

Tango Short

LED PIR MOTION SENSOR 230V AC

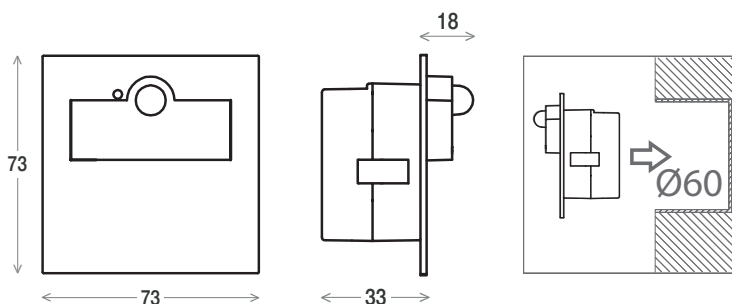

Specifications • Parametry techniczne • Technische Parameter



INDEX		W		CCT	lm	lm/W	IP	IK	KG
MN-TAN-K-W-1-ML-ML-01	K	2,4 W	W	6500 K	22	9	20	09	0,113
MN-TAN-K-N-1-ML-ML-01	K	2,4 W	N	4000 K	22	9	20	09	0,113
MN-TAN-K-H-1-ML-ML-01	K	2,4 W	H	3000 K	21	9	20	09	0,113
MN-TAN-K-B-1-ML-ML-01	K	2,4 W	B	niebieski	-	-	20	09	0,113
MN-TAN-G-W-1-ML-ML-01	G	2,4 W	W	6500 K	22	9	20	09	0,109
MN-TAN-G-N-1-ML-ML-01	G	2,4 W	N	4000 K	22	9	20	09	0,109
MN-TAN-G-H-1-ML-ML-01	G	2,4 W	H	3000 K	21	9	20	09	0,109
MN-TAN-G-B-1-ML-ML-01	G	2,4 W	B	niebieski	-	-	20	09	0,109
MN-TAN-D-W-1-ML-ML-01	D	2,4 W	W	6500 K	22	9	20	09	0,109
MN-TAN-D-N-1-ML-ML-01	D	2,4 W	N	4000 K	22	9	20	09	0,109
MN-TAN-D-H-1-ML-ML-01	D	2,4 W	H	3000 K	21	9	20	09	0,109
MN-TAN-D-B-1-ML-ML-01	D	2,4 W	B	niebieski	-	-	20	09	0,109
MN-TAN-C-W-1-ML-ML-01	C	2,4 W	W	6500 K	22	9	20	09	0,109
MN-TAN-C-N-1-ML-ML-01	C	2,4 W	N	4000 K	22	9	20	09	0,109
MN-TAN-C-H-1-ML-ML-01	C	2,4 W	H	3000 K	21	9	20	09	0,109
MN-TAN-C-B-1-ML-ML-01	C	2,4 W	B	niebieski	-	-	20	09	0,109



Range • Zasięg • Reichweite

EN: Sensor range for static movement 3-4m / 120°
PL: Zasięg czujnika przy ruchu stycznym 3-4 m / 120°
DE: Sensorbereich für statische Bewegung 3-4 m / 120°



Intensity • Natężenie • Intensität

EN: Light reaction threshold adjustment external in the range of 2-40 lx.
PL: Regulacja progu reakcji na światło zewnętrzne w zakresie 2-40 lx.
DE: Einstellung der Lichtreaktionsschwelle extern im Bereich von 2-40 lx.



Time • Czas • Zeit

EN: Activation time from 3-35 s.
PL: Czas załączenia 3-35 s.
DE: Einschaltdauer von 3-35 s.

Use

For illumination of circulation routes, stairs, stair risers, cabinet fronts, or for attractive light decoration of walls.
For switch lighting or other receivers on and off.

Further information

Material: stainless steel (INOX), aluminium
Light source: non-exchangeable LED modules
Method of installation: back box Ø 60 mm
CN Code: 94052990
Max. sensor load: 3A / 230 V AC

WARRANTY

Warranty: 36 months

Finishing • Wykończenie • Verarbeitungsart



Colour of light • Barwa światła • Lichtfarbe



Zastosowanie

Do oświetlenia ciągów komunikacyjnych, schodów, podstopnic, witryn meblowych, lub do efektywnego dekorowanie światłem ścian.
Do załączania i wyłączania oświetlenia lub innych odbiorników.

Informacje dodatkowe

Material: stal szlachetna (INOX), aluminium
Źródło światła: niewymienialne moduły LED
Sposób montażu: puszka Ø 60 mm
Kod CN: 94052990
Max. obciążenia czujnika: 3A / 230 V AC

GWARANCJA

Gwarancja: 36 miesięcy

Photometry • Fotometria • Photometrie

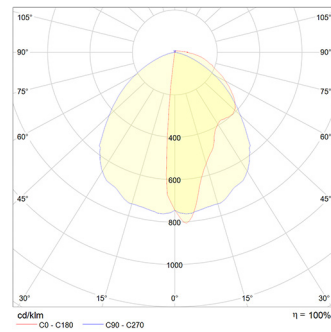

Verwendung

Für die Beleuchtung der Verkehrsstränge, Treppen, Setzstufen, Vitrinen oder für eine effektvolle dekorative Wandbeleuchtung.
Für die Beleuchtung oder andere Empfänger ein- und ausschalten.

Zusätzliche Angaben

Material: Edelstahl (INOX), aluminium
Leuchtmittel: nicht austauschbare LED-Module
Montage: in einer Installationsdose Ø 60 mm
CN-Code: 94052990
Max. Sensorlast: 3A / 230 V AC

GARANTIE

Garantie: 36 Monate

Standards • Normy • Normen











PN-EN 62471:2012
PN-EN 62031:2020-08
PN-EN 61547:2009
PN-EN 55015:2019-11
PN-EN 62493:2015-11
PN-EN 60598-1:2021-07
PN-EN 60598-2-1:2021-09
PN-EN 50581:2013-03
PN-EN 61000-4-2:2011
PN-EN 61000-4-3:2021-06
PN-EN 61000-4-4:2013-05
PN-EN 61000-4-5:2014-10
PN-EN 61000-4-6:2014-04
PN-EN 61000-4-11:2020-11















Legend

Objaśnienia znaków • Legende













Installation • Montaż • Montage

	Cabinet mounted lighting with wide beam angle Oświetlenie meblowe do zabudowy z szerokim kątem świecenia Beleuchtung mit breitem Lichtwinkel für die Einbaumöbel
	Cabinet mounted lighting with narrow beam angle Oświetlenie meblowe do zabudowy z wąskim kątem świecenia Beleuchtung mit schmalem Lichtwinkel für die Einbaumöbel
	Cabinet top-mounted lighting with wide beam angle Oświetlenie meblowe do nabudowy z szerokim kątem świecenia Beleuchtung mit breitem Lichtwinkel für die Aufbaumöbel
	Overhead furniture lights Oświetlenie meblowe do nabudowy z wąskim kątem świecenia Beleuchtung mit schmalem Lichtwinkel für die Aufbaumöbel
	Furniture lights mounted on glazing Oświetlenie meblowe do montażu na szybie Furniture lights mounted on glazing
	Built-in wide angle lights Oświetlenie sufitowe do zabudowy z szerokim kątem świecenia Einbauleuchten mit weitem Lichtwinkel
	Overhead wide angle lights Oświetlenie sufitowe do nabudowy z szerokim kątem świecenia Aufbauleuchten mit weitem Lichtwinkel
	Wall-mounted wide angle lights Oświetlenie ścienne z szerokim kątem świecenia Wandleuchten mit weitem Lichtwinkel
	Hanging wide angle lights Oświetlenie sufitowe wiszące z szerokim kątem świecenia Hängeleuchten mit weitem Lichtwinkel
	Floor lighting with wide beam angle Oświetlenie podłogowe z szerokim kątem świecenia Bodenbeleuchtung mit breitem Lichtwinkel

























Finishing • Wykończenie • Verarbeitungsart

	Surface Finishing Wykończenie powierzchni Oberflächenverarbeitung
	Stainless steel (INOX) Stal nierdzewna (INOX) Edelstahl (INOX)
	Chrome plating Chrom Chrom
	White Biały Weiß
	Black Czarny Schwarz
	Aged brass Mosiądz starzony Altmessing
	Aluminium Aluminium Aluminium
	Brushed nickel Szczotkowany nikiel Nickel gebürstet
	Brushed stainless steel (INOX) Szczotkowana stal nierdzewna (INOX) Edelstahl gebürstet (INOX)
	Mirror (INOX) Lustro (INOX) Spiegelblank (INOX)
	Matte brass Mosiądz mat Messing matt
	Champagne Szampański Champagne
	Transparent Przezroczysty Transparent













Light specifications • Parametry świetlne • Licht-Spezifikationen

	LED Light source Źródło światła LED LED-Leuchtmittel
	Replaceable Light source Wymienne źródło światła Austauschbares Leuchtmittel
	Colour of light Barwa światła Lichtfarbe
	6500K - Kaltweiß 6500K - Zimny biały 6500K - Cool white
	4000K - Neutral 4000K - Neutralny 4000K - Neutral
	3000K - White warm 3000K - Ciepły biały 3000K - Warmweiß
	Blue Niebieski Blau
	Colour rendering index Współczynnik oddawania barw Farbwiedergeindex
	Colour temperature Temperatura barwowa Farbtemperatur
	The upper limit temperature of white colour Górna granica temperatury koloru białego Die obere Grenztemperatur der weißen Farbe
	The lower limit temperature of white colour Dolna granica temperatury koloru białego Die untere Grenztemperatur der weißen Farbe
	LED light flux Strumień świetlny diody LED LED-Lichtstrom
	Luminare light flux Strumień świetlny oprawy Lichtstrom der Leuchte
	Luminous efficacy luminaire Skuteczność świetlna oprawy Lichtausbeute der Leuchte

Specifications • Parametry techniczne • Technische Parameter

	Rated power Moc znamionowa Nennleistung		Min. operating temperature Minimalna temperatura pracy Minimale Betriebstemperatur
	LED power Moc diody LED LED-Leistung		Max. operating temperature Maksymalna temperatura pracy Maximale Betriebstemperatur
	Fixture power Moc oprawy Leistung der Leuchte		Constant current Stabilizacja prądowa (Constant Current) Stromstabilisierung (Constant Current)
	DC voltage Wartość napięcia prądu stałego Spannung Konstantstrom		Constant voltage Stabilizacja napięciowa (Constant Voltage) Spannungsstabilisierung (Constant Voltage)
	AC voltage Wartość napięcia prądu zmiennego Spannung Wechselstrom		PF (Power Factor) Wartość PF (Power Factor) PF-Wert (Power Factor)
	Tightness Szczelność Dichtheit		Input voltage Napięcie wejściowe Eingangsspannung
	Resistance Wytrzymałość Beständigkeit		Output voltage Napięcie wyjściowe Ausgangsspannung
	Protection class I I klasa ochronności Schutzklasse I		
	Protection class II II klasa ochronności Schutzklasse II		
	Protection class III III klasa ochronności Schutzklasse I		
	Device independent of lamps Urządzenie niezależne od lamp Gerät unabhängig von Leuchten		
	Short-circuit and overload proof safety transformer Transformator bezpieczeństwa odporny na zwarcia i przeciążenia. Sicherheitstransformator geschützt gegen Kurzschluss und Überlastung.		
	SELV protection Ochrona SELV Schutzkleinspannung SELV		
	Beam angle Kąt świecenia Lichtwinkel		
	Min. distance from illuminated item Min. odległość od oświetlanego obiektu Mindestabstand zum beleuchteten Objekt		
	Weight Waga Gewicht		
	Single LED tape module dimensions Wymiar pojedynczego modułu taśmy LED Abmessungen des Einzelmoduls eines LED-Streifens		

Performance parameters • Parametry użytkowe • Performance-Parameter

	Compatibility with SKOFF &More System Kompatybilność z systemem SKOFF &More Kompatibilität mit dem SKOFF &More System
	Compatibility with intelligent home systems Kompatybilność z systemami inteligentnego domu Kompatibel mit Smart-Home-Systemen
	Compatibility with DALI light controlling system Kompatybilność z systemem sterowania DALI Kompatibilität mit DALI Lichtregelsystem
	Dimming options Możliwość ściemniania Steuerung der Helligkeit
	No dimming Brak możliwości ściemniania Keine Steuerung der Helligkeit
	Emitting light colour change available Możliwość zmiany barwy koloru światła Ausstrahlende helle Farbenänderung vorhanden
	Emitting light colour change not available Brak możliwości zmiany barwy koloru światła Lichtaustritt ist nicht möglich
	Low glare index Niski współczynnik ośnienia Niedriger Blendungsindex
	Compliance with RoHS Zgodność z wymaganiami RoHS Entspricht den RoHS-Richtlinien
	Compliance with CE Directive Zgodność z dyrektywą CE Entspricht der CE-Richtlinie
	Compliance with WEEE Directive Zgodność z dyrektywą WEEE Entspricht der WEEE-Richtlinie
	Compliance with cRUus requirements Zgodność z wymaganiami cRUus Entspricht den cRUus-Anforderungen
	SKOFF item no. Numer indeksu SKOFF SKOFF Index-Nr.
	3M technology is implemented in the product W produkcie zastosowano technologię firmy 3M Im Produkt wurde die Technologie vom 3M

© SKOFF 2022

We protect our Intellectual Property Rights • Chronimy nasze prawa własności intelektualnej • Wir schützen unsere Rechte am geistigen Eigentum.

We reserve our rights for technical modifications • Zastrzegamy sobie prawo do wprowadzania zmian technicznych • Technische Änderungen vorbehalten.