







QUICKTRONIC® INTELLIGENT T/E DIM

	QTi-T/E 1X18-57 DIM	QTi-T/E 2X18-42 DIM
10A (B) 	12 x 	8 x 
16A (B) 	19 x 	13 x 
	≤ 30A	≤ 45 A
T_H	225 μs	204 μs

QTi-T/E 1X18-57 DIM

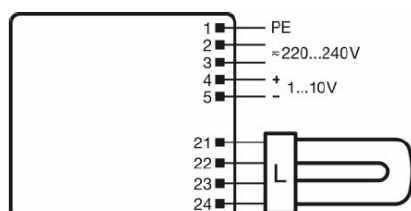

QTi-T/E 2X18-42 DIM

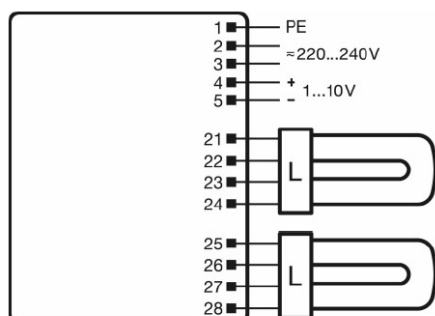

Max. permitted cable length between ECG and lamp: 0,5 m (PIN 21, 22, 23, 24)

- Ⓓ Max. Leitungslänge zwischen EVG und Lampe; Leitungslänge max.
- ⓇⓊⓈ Макс.длина кабеля между прибором и лампой
- ⓀⓏ Құрылғы мен шам арасындағы кабельдің максималды ұзындығы.

