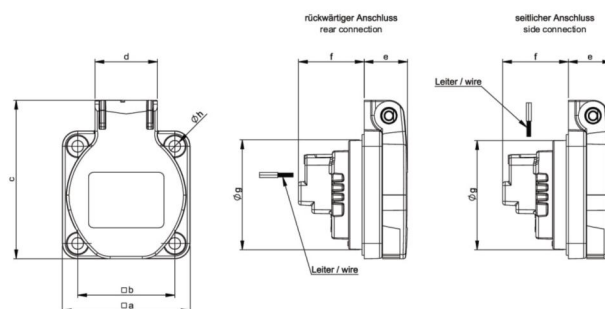

PCE data sheet

article#	104-0bsc
article description	Socket outlet with protective contact 50x50 fb shutter IP54 side (blue)
description long	Socket outlet with protective earth contact series S-NOVA housing material: PA6, color: blue flange size: 50x50 mm connection technology: screw terminal, side entry system: French/Belgian (earth pin) + shutter contacts: nickel plated 250V / 16A / 2P+E , protection rating: IP54
GTIN (EAN)	9003399095368
country of origin	AT
customs number	85366990
net weight	0.046 kg
packaging quantity	100
minimum order quantity	100

ETIM 7.0	EC001325
Model	Earthing pin
Material	Plastic
Material quality	Thermoplastic
Halogen free	True
Flange size	50x50 mm
With hinged lid	True
For heavy conditions (in accordance with VDE)	True
Degree of protection (IP)	IP54
Angle of plug	Straight
Connection system	Schraubklemme
Colour	Blue
RAL-number	5017
Number of poles	3
Nominal current	16 A
Nominal voltage	250 V

www.manufacturer-safety.info