

PCE data sheet

article#	192-10v
article description	CEE-wall mounted socket 32A 2p 24/42VDC IP44 TWIST
description long	CEE-wall mounted socket 32A 2p 24/42VDC IP44 TWIST housing material: PA6 rated current: 32A number of poles: 2 (2P) clock-position: 10h rated voltage/frequency: 24/42V DC contacts: brass nickel plated connection technology: screw terminals IP protection class: IP44
GTIN (EAN)	9003399029257
country of origin	AT
customs number	85366990
net weight	0.220 kg
packaging quantity	10
minimum order quantity	10

ETIM 7.0	EC001321
IEC-amperage	32 A
Number of poles	2
Voltage acc. EN 60309-2	<50 V DC grey
Clock hour position	10 h
Identification colour	White
Degree of protection (IP)	IP44
Connection system	Schraubklemme
Cable entry	Verschraubung
Material	Plastic
Type of fastening	External mounting
Insulated mounting	True

a	124 mm
wire flexible	1-10 mm ²
wire solid	1,5-10 mm ²
contact screws	160 Ncm
dismantling length	70 mm
stripping length	14-16 mm

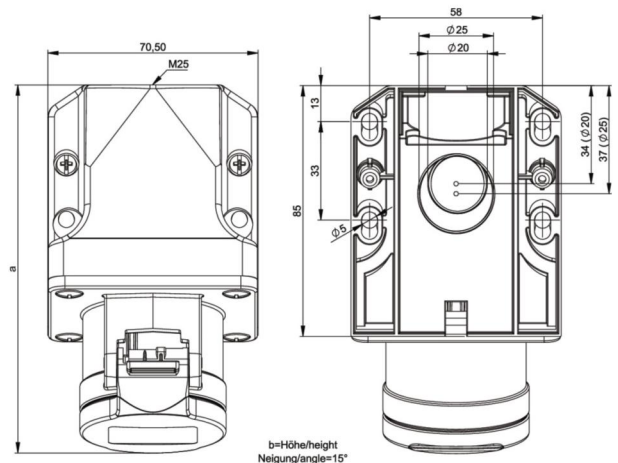

www.manufacturer-safety.info