

PCE data sheet

article#	75233-6
article description	CEE-wall mounted socket mit Fenster 32A 3p 6h IP44
description long	CEE-wall mounted socket with window 32A 3p 6h IP44 housing material: PC/ABS rated current: 32A number of poles: 3 (2P+PE) clock-position: 6h rated voltage/frequency: 200-250V~ / 50+60Hz contacts: brass nickel plated connection technology: screw terminals cable entry: top, bottom, rear inc. threaded blind cap with hinged window (5 modules) and DIN rail IP protection class: IP44
GTIN (EAN)	9003399982804
country of origin	AT
customs number	85366990
net weight	0.972 kg
packaging quantity	1

ETIM 7.0	EC000379
CEE socket outlet 16 A	
CEE socket outlet 32 A	
Number of socket outlets with protective contact	
Other fixtures and/or empty locations	5
Material housing	Plastic
Handling	Wall mounting
Degree of protection (IP)	IP54
Colour	Grey

wire flexible	2,5-6 mm ²
wire solid	2,5-10 mm ²
contact screws	110 Ncm
dismantling length	50 mm
stripping length	12-14 mm

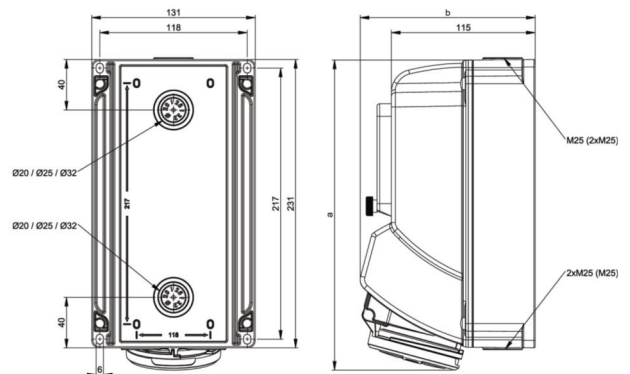

www.manufacturer-safety.info