

PCE data sheet

article#	1132-10v
article description	CEE-wall mounted socket 16A 3p 10h IP67
description long	CEE-wall mounted socket 16A 3p 10h IP67 housing material: PA6 rated current: 16A number of poles: 3 (2P+PE) clock-position: 10h rated voltage/frequency: >50V~ / 100-300Hz contacts: brass nickel plated connection technology: screw terminals cable entry: top and rear incl. threaded cable gland IP protection class: IP67
GTIN (EAN)	9003399129308
country of origin	AT
customs number	85366990
net weight	0.226 kg
packaging quantity	5

ETIM 7.0	EC001321
Model	Surface mounted (plaster)
IEC-amperage	16 A
Number of poles	3
Voltage acc. EN 60309-2	50-500 V (100-300 Hz) green
Clock hour position	10 h
Identification colour	Green
RAL-number	
Degree of protection (IP)	IP67
Connection system	Screwed terminal
Cable entry	Swivel
Material	Plastic
Contact material	CuZn
Surface finish contacts	Nickel-plated
Type of fastening	External mounting

wire flexible	1-2,5 mm ²
wire solid	1-4 mm ²
contact screws	100 Ncm
dismantling length	50 mm
stripping length	10-12 mm

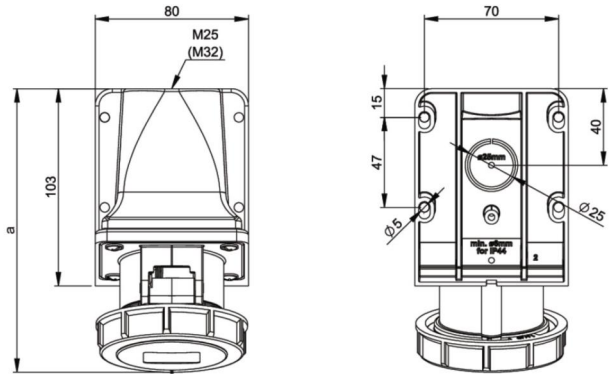

b=Höhe/height
Neigung/angle=15°



www.manufacturer-safety.info