

PCE data sheet

article#	1242-7
article description	CEE-wall mounted socket 32A 4p 7h IP67
description long	CEE-wall mounted socket 32A 4p 7h IP67 housing material: PA6 rated current: 32A number of poles: 4 (3P+PE) clock-position: 7h rated voltage/frequency: 480-500V~ / 50+60Hz contacts: brass connection technology: screw terminals cable entry: top and rear incl. threaded cable gland IP protection class: IP67
GTIN (EAN)	9003399175497
country of origin	AT
customs number	85366990
net weight	0.314 kg
packaging quantity	5

ETIM 7.0	EC001321
Model	Surface mounted (plaster)
IEC-amperage	32 A
Number of poles	4
Voltage acc. EN 60309-2	500 V (50+60 Hz) black
Clock hour position	7 h
Identification colour	Black
RAL-number	
Degree of protection (IP)	IP67
Connection system	Screwed terminal
Cable entry	Swivel
Material	Plastic
Contact material	CuZn
Surface finish contacts	Untreated
Type of fastening	External mounting

wire flexible	2,5-6 mm ²
wire solid	2,5-10 mm ²
contact screws	110 Ncm
dismantling length	50 mm
stripping length	12-14 mm

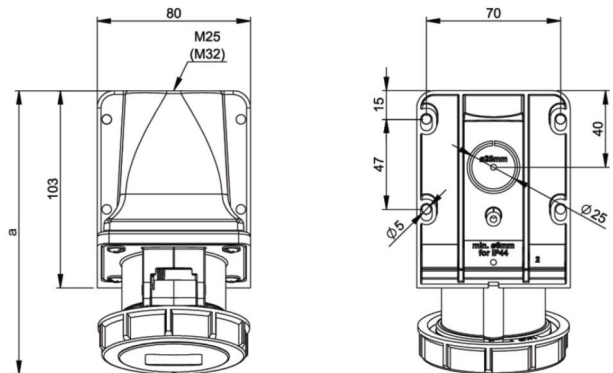

www.manufacturer-safety.info