

PCE data sheet

article#	615-6f6
article description	CEE-flanged plug 60x60 straight 16A 5p 6h IP44
description long	CEE-flanged plug 60x60 straight 16A 5p 6h IP44 housing material: PA6 rated current: 16A number of poles: 5 (3P+N+PE) clock-position: 6h rated voltage/frequency: 200/346V~ - 240/415V~ / 50+60Hz contacts: brass connection technology: screw terminals dimensions (flange/fixing center): 60x60 mm / 50x50 mm IP protection class: IP44
GTIN (EAN)	9003399067341
country of origin	AT
customs number	85366990
net weight	0.109 kg
packaging quantity	10
minimum order quantity	10

ETIM 7.0	EC001319
IEC-amperage	16 A
Voltage acc. EN 60309-2	400 V (50+60 Hz) red
Number of poles	5
Clock hour position	6 h
Identification colour	Red
Degree of protection (IP)	IP44
Connection system	Screwed terminal
Construction type	Built-up device plug
Angle of plug	Straight
Material	Plastic
Contact material	CuZn
Surface finish contacts	Untreated

wire flexible	1-2,5 mm ²
wire solid	1-4 mm ²
contact screws	100 Ncm
dismantling length	50 mm
stripping length	10-12 mm

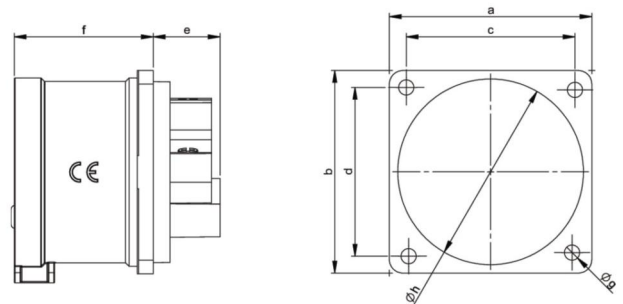

www.manufacturer-safety.info