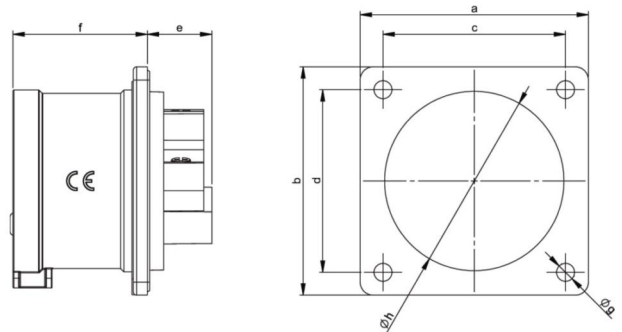

PCE data sheet

article#	614-4
article description	CEE-flanged plug 70x70 straight 16A 4p 4h IP44
description long	CEE-flanged plug 70x70 straight 16A 4p 4h IP44 housing material: PA6 rated current: 16A number of poles: 4 (3P+PE) clock-position: 4h rated voltage/frequency: 100-130V~ / 50+60Hz contacts: brass connection technology: screw terminals dimensions (flange/fixing center): 70x70 mm / 56x56 mm IP protection class: IP44
GTIN (EAN)	9003399066788
country of origin	AT
customs number	85366990
net weight	0.101 kg
packaging quantity	10
minimum order quantity	10

ETIM 7.0	EC001319
IEC-amperage	16 A
Voltage acc. EN 60309-2	110 V (50+60 Hz) yellow
Number of poles	4
Clock hour position	4 h
Identification colour	Yellow
Degree of protection (IP)	IP44
Connection system	Screwed terminal
Construction type	Built-up device plug
Angle of plug	Straight
Material	Plastic
Contact material	CuZn
Surface finish contacts	Untreated

wire flexible	1-2,5 mm ²
wire solid	1-4 mm ²
contact screws	100 Ncm
dismantling length	50 mm
stripping length	10-12 mm

www.manufacturer-safety.info