

PCE data sheet

article#	513-7
article description	CEE-wall mounted plug 16A 3p 7h IP44
description long	CEE-wall mounted plug 16A 3p 7h IP44 housing material: PA6 rated current: 16A number of poles: 3 (2P+PE) clock-position: 7h rated voltage/frequency: 480-500V~ / 50+60Hz contacts: brass connection technology: screw terminals IP protection class: IP44
GTIN (EAN)	9003399057625
country of origin	AT
customs number	85366990
net weight	0.173 kg
packaging quantity	10
minimum order quantity	10

ETIM 7.0	EC001319
IEC-amperage	16 A
Voltage acc. EN 60309-2	500 V (50+60 Hz) black V
Number of poles	3
Clock hour position	7 h
Identification colour	Black
Degree of protection (IP)	IP44
Connection system	Screwed terminal
Construction type	Surface mounted plug
Phase inverter	False
Angle of plug	Angled
Material	Plastic
Contact material	CuZn
Surface finish contacts	Untreated

wire flexible	1-2,5 mm ²
wire solid	1-4 mm ²
contact screws	100 Ncm
dismantling length	50 mm
stripping length	10-12 mm

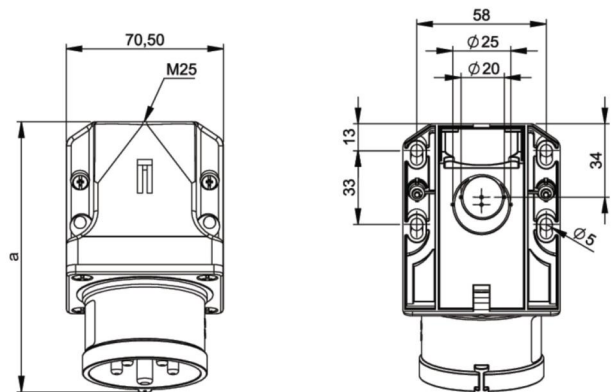

b=Höhe/height
Neigung/angle=15°



www.manufacturer-safety.info