

Maßskizze / dimensional drawing

Benennung: Kupplung 125A IP66/67 POWERTWIST

description: Connector 125A IP66/67 POWERTWIST

Teilenummer / part number: 243-*, 244-*, 245-*

PCE

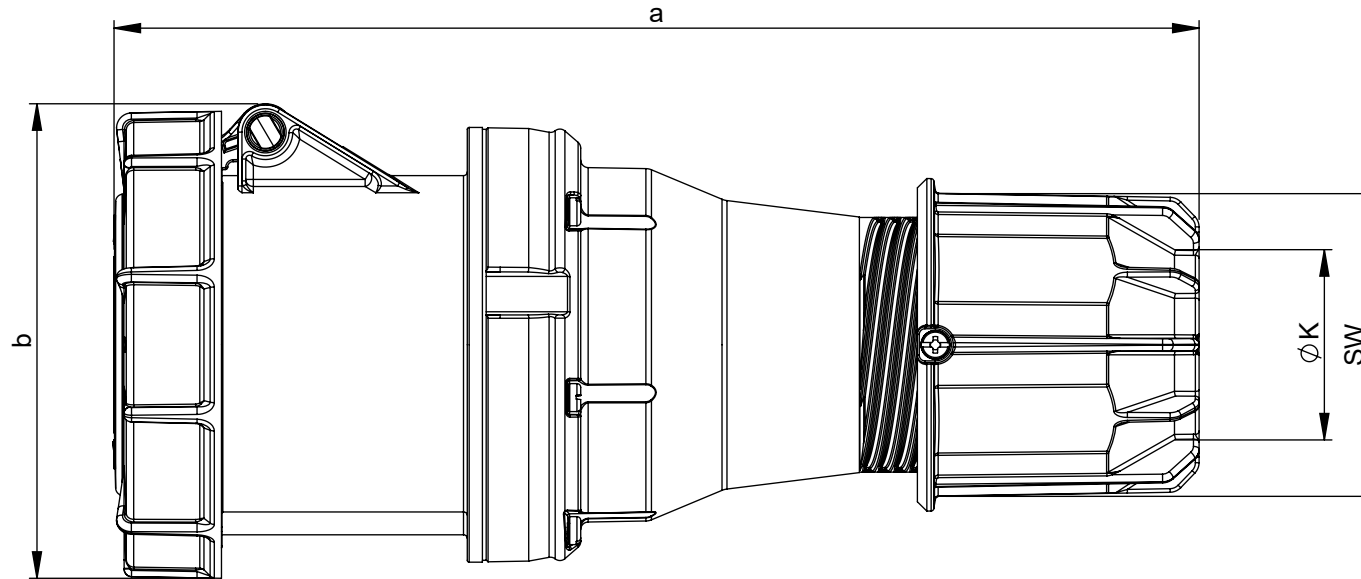

Ampere	125		
Pole	3	4	5
a [mm]	287	287	287
b [mm]	124	124	124
K [mm]	22,5-50	22,5-50	22,5-50
SW [mm]	81	81	81