

PCE data sheet

| | |
|------------------------|---|
| article# | 0232-7 |
| article description | CEE-plug 32A 3p 7h IP67 SHARK |
| description long | CEE-plug 32A 3p 7h IP67 SHARK housing material: PA6 rated current: 32A number of poles: 3 (2P+PE) clock-position: 7h rated voltage/frequency: 480-500V~ / 50+60Hz contacts: brass connection technology: screw terminals IP protection class: IP66/IP67 |
| GTIN (EAN) | 9003399139338 |
| country of origin | AT |
| customs number | 85366990 |
| packaging quantity | 10 |
| minimum order quantity | 10 |

| | |
|----------------------------|------------------------|
| ETIM 7.0 | EC000140 |
| IEC-amperage | 32 A |
| Number of poles | 3 |
| Voltage acc. EN 60309-2 | 500 V (50+60 Hz) black |
| Clock hour position | 7 h |
| Identification colour | Black |
| Degree of protection (IP) | IP67 |
| Connection system | Screwed terminal |
| Cable entry | Swivel |
| Angle of plug | Straight |
| Material | Plastic |
| Contact material | CuZn |
| Surface treatment contacts | Untreated |

| | |
|--------------------|-----------------------|
| a | 150 mm |
| b | 93 mm |
| K (cable Ø) | 11,5-20 mm |
| SW | 50 mm |
| wire flexible | 2,5-6 mm ² |
| contact screws | 110 Ncm |
| strain relief | 600 Ncm |
| dismantling length | 50 mm |
| stripping length | 12-14 mm |

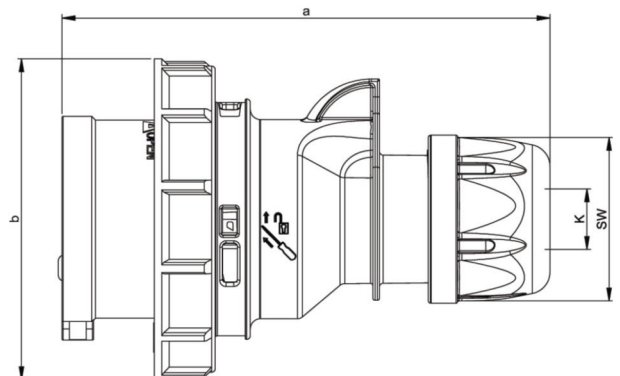

www.manufacturer-safety.info