

PCE data sheet

article#	4142-6
article description	CEE-flanged socket sloping (92x100mm) 16A 4p 6h IP67
description long	CEE-flanged socket sloping (92x100mm) 16A4p 6h IP67 housing material: PA6 rated current: 16A number of poles: 4 (3P+PE) clock-position: 6h rated voltage/frequency: 380-415V~ / 50+60Hz contacts: brass connection technology: screw terminals dimensions (flange/fixing center): 92x100 mm / 77x85 mm IP protection class: IP67
GTIN (EAN)	9003399134807
country of origin	AT
customs number	85366990
net weight	0.167 kg
packaging quantity	10

ETIM 7.0	EC001317
IEC-amperage	16 A
Voltage acc. EN 60309-2	400 V (50+60 Hz) red
Number of poles	4
Clock hour position	6 h
Identification colour	Red
Degree of protection (IP)	IP67
Connection system	Screw terminal
Angle of plug	Angled
Material	Plastic
Contact material	CuZn
Surface finish contacts	Untreated
Flange size vertical	100 mm
Drill hole distance vertical	85 mm
Flange size horizontal	92 mm
Drill hole distance horizontal	77 mm

wire flexible	1-2,5 mm ²
wire solid	1-4 mm ²
contact screws	100 Ncm
dismantling length	50 mm
stripping length	10-12 mm

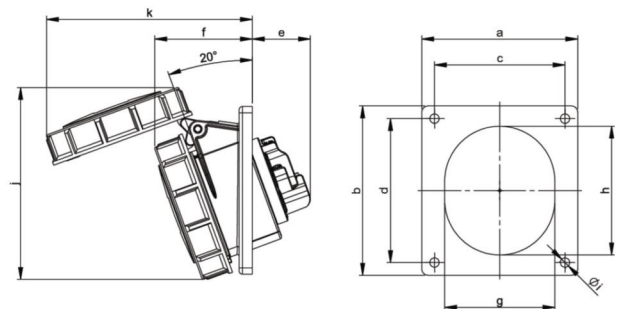

www.manufacturer-safety.info