

# PCE data sheet

article#	<b>7524-6</b>
article description	<b>CEE-switched interlocked socket 32A 4p 6h IP44/IP54</b>
description long	CEE-switched interlocked socket 32A 4p 6h IP44/IP54 housing material: PC/ABS rated current: 32A number of poles: 4 (3P+PE) clock-position: 6h rated voltage/frequency: 380-415V~ / 50+60Hz contacts: brass nickel plated connection technology: screw terminals wall mounting, mechanical interlock switch: ON/OFF PCE-Merz ML0; EN 60947-3; AC22A, 10kA cable entry: top, bottom or rear (incl. threaded blind cap) IP protection class: IP44/IP54
GTIN (EAN)	9003399168956
country of origin	AT
customs number	85366990
net weight	1.111 kg
packaging quantity	1

ETIM 7.0	EC001324
IEC-amperage	32 A
Number of poles	4
Voltage acc. EN 60309-2	400 V (50+60 Hz) red
Clock hour position	6 h
Identification colour	Red
Degree of protection (IP)	IP54
Switch	Mechanical locking
Material housing	Plastic
Model	Base unit and cover
Contact material	CuZn
Surface finish contacts	Nickel-plated

wire flexible	2,5-6 mm <sup>2</sup>
wire solid	2,5-10 mm <sup>2</sup>

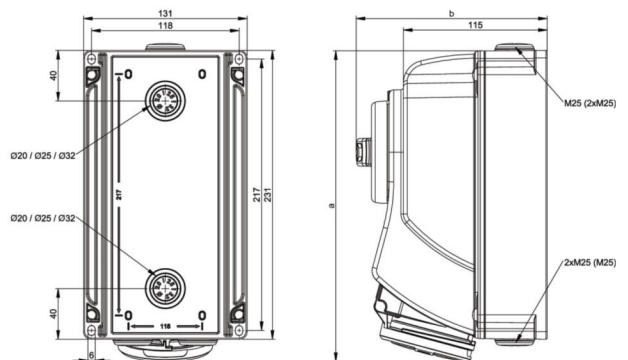

[www.manufacturer-safety.info](http://www.manufacturer-safety.info)