

PCE data sheet

article#	7523-6
article description	CEE-switched interlocked socket 32A 3p 6h IP44/IP54
description long	CEE-switched interlocked socket 32A 3p 6h IP44/IP54 housing material: PC/ABS rated current: 32A number of poles: 3 (2P+PE) clock-position: 6h rated voltage/frequency: 200-250V~ / 50+60Hz contacts: brass nickel plated connection technology: screw terminals wall mounting, mechanical interlock switch: ON/OFF PCE-Merz ML0; EN 60947-3; AC22A, 10kA cable entry: top, bottom or rear (incl. threaded blind cap) IP protection class: IP44/IP54
GTIN (EAN)	9003399151606
country of origin	AT
customs number	85366990
net weight	1.104 kg
packaging quantity	1

ETIM 7.0	EC001324
IEC-amperage	32 A
Number of poles	3
Voltage acc. EN 60309-2	230 V (50+60 Hz) blue
Clock hour position	6 h
Identification colour	Blue
Degree of protection (IP)	IP54
Switch	Mechanical locking
Material housing	Plastic
Model	Base unit and cover
Contact material	CuZn
Surface finish contacts	Nickel-plated

wire flexible	2,5-6 mm ²
wire solid	2,5-10 mm ²

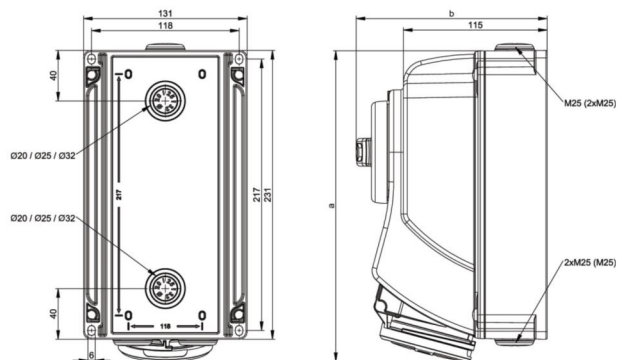

www.manufacturer-safety.info