

**WP-A**

- (GB) Mounting instructions
- (DE) Montageanleitung
- (SI) Navodilo za montažo
- (PL) Instrukcje montażu
- (HR) Upute za montažu
- (CZ) Montážní návod
- (SK) Navod na montáž
- (HU) Szerelesési utmutató
- (LT) Montavimo instrukcija
- (RU) Инструкция за монтаж
- (LV) Montāžas instrukcija
- (EST) Paigaldusjuhend

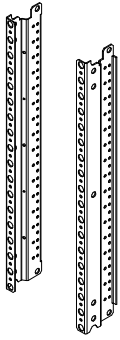

Hole in WP-A left  
(Otwór w WP-A lewym)

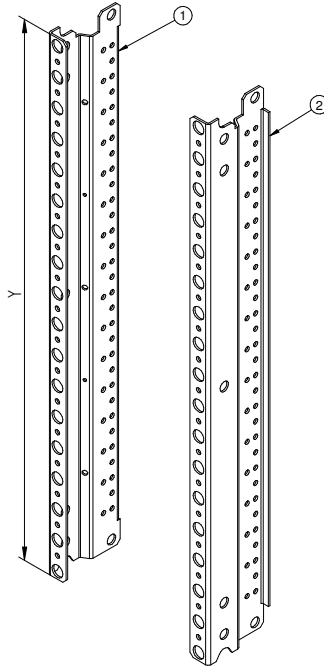

**SOLID GSX Enclosure system**

Type	Y	(1)	Pcs.	(2)	Pcs.
WP-A 2	288 mm	WP-A 2L	1	WP-A 2P	1
WP-A 2.33	338 mm	WP-A 2.33L	1	WP-A 2.33P	1
WP-A 3	438 mm	WP-A 3L	1	WP-A 3P	1
WP-A 3.66	538 mm	WP-A 3.66L	1	WP-A 3.66P	1
WP-A 4	588 mm	WP-A 4L	1	WP-A 4P	1
WP-A 5	738 mm	WP-A 5L	1	WP-A 5P	1
WP-A 6	888 mm	WP-A 6L	1	WP-A 6P	1
WP-A 6.33	938 mm	WP-A 6.33L	1	WP-A 6.33P	1
WP-A 7	1038 mm	WP-A 7L	1	WP-A 7P	1
WP-A 7.66	1138 mm	WP-A 7.66L	1	WP-A 7.66P	1
WP-A 8	1188 mm	WP-A 8L	1	WP-A 8P	1
WP-A 9	1338 mm	WP-A 9L	1	WP-A 9P	1
WP-A 10	1488 mm	WP-A 10L	1	WP-A 10P	1
WP-A 11	1638 mm	WP-A 11L	1	WP-A 11P	1
WP-A 12	1788 mm	WP-A 12L	1	WP-A 12P	1
WP-A 13	1938 mm	WP-A 13L	1	WP-A 13P	1

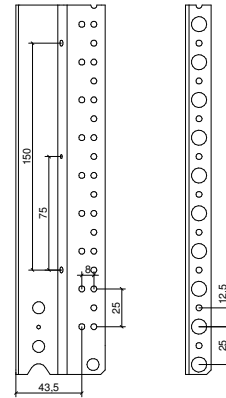

**WP-A**

- (GB) Mounting instructions
- (DE) Montageanleitung
- (SI) Navodilo za montažo
- (PL) Instrukcje montażu
- (HR) Upute za montažu
- (CZ) Montážní návod
- (SK) Navod na montáž
- (HU) Szerelesési utmutató
- (LT) Montavimo instrukcija
- (RU) Инструкция за монтаж
- (LV) Montāžas instrukcija
- (EST) Paigaldusjuhend

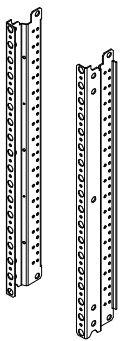

Hole in WP-A left  
(Otwór w WP-A lewym)

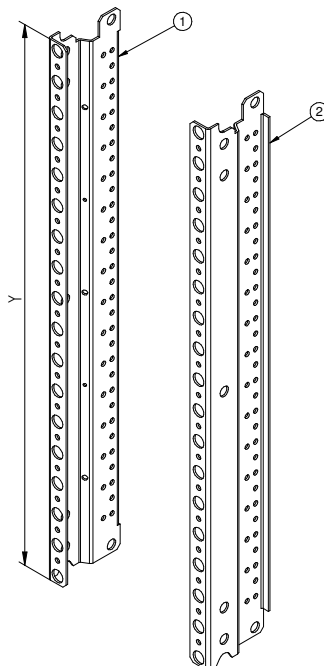

**SOLID GSX Enclosure system**

Type	Y	(1)	Pcs.	(2)	Pcs.
WP-A 2	288 mm	WP-A 2L	1	WP-A 2P	1
WP-A 2.33	338 mm	WP-A 2.33L	1	WP-A 2.33P	1
WP-A 3	438 mm	WP-A 3L	1	WP-A 3P	1
WP-A 3.66	538 mm	WP-A 3.66L	1	WP-A 3.66P	1
WP-A 4	588 mm	WP-A 4L	1	WP-A 4P	1
WP-A 5	738 mm	WP-A 5L	1	WP-A 5P	1
WP-A 6	888 mm	WP-A 6L	1	WP-A 6P	1
WP-A 6.33	938 mm	WP-A 6.33L	1	WP-A 6.33P	1
WP-A 7	1038 mm	WP-A 7L	1	WP-A 7P	1
WP-A 7.66	1138 mm	WP-A 7.66L	1	WP-A 7.66P	1
WP-A 8	1188 mm	WP-A 8L	1	WP-A 8P	1
WP-A 9	1338 mm	WP-A 9L	1	WP-A 9P	1
WP-A 10	1488 mm	WP-A 10L	1	WP-A 10P	1
WP-A 11	1638 mm	WP-A 11L	1	WP-A 11P	1
WP-A 12	1788 mm	WP-A 12L	1	WP-A 12P	1
WP-A 13	1938 mm	WP-A 13L	1	WP-A 13P	1

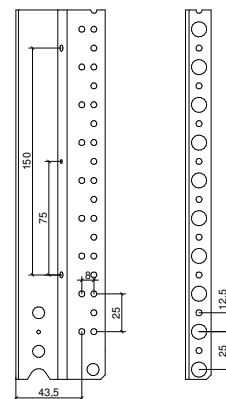



Power needs control

# SOLID GSX Enclosure system

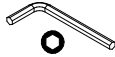

Hex5  
(Klucz imbusowy 5)

1	AS-SH 6x10	3,6-6,0 Nm
2	AW-R 6	-

WP-A

Step 1  
(Krok 1)

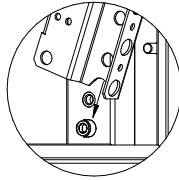
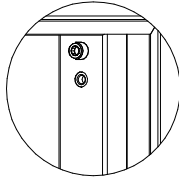
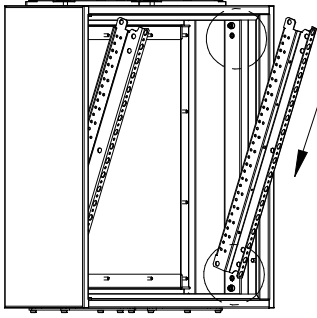

Step 2  
(Krok 2)

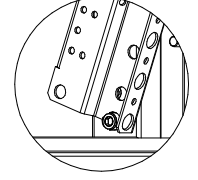
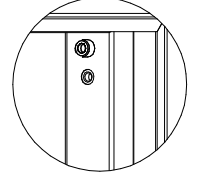
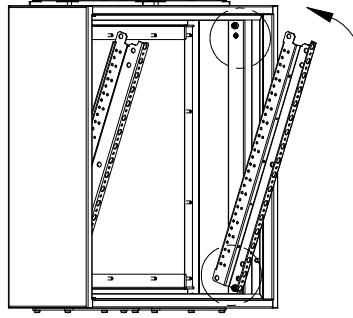

Step 3  
(Krok 3)

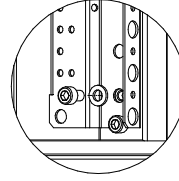
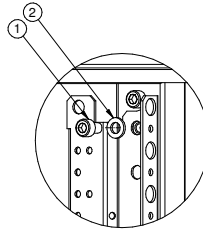
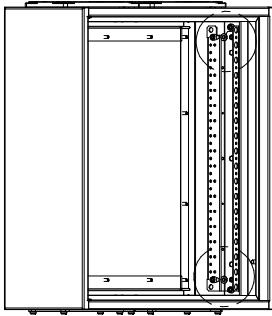

Step 4  
(Krok 4)

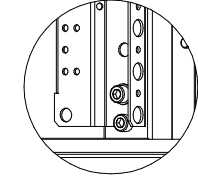
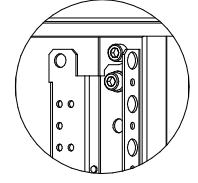
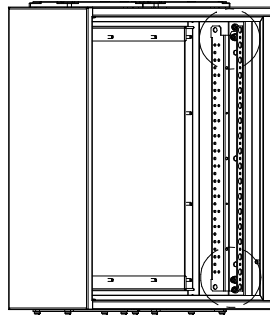

Power needs control

# SOLID GSX Enclosure system

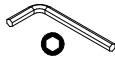

Hex5  
(Klucz imbusowy 5)

1	AS-SH 6x10	3,6-6,0 Nm
2	AW-R 6	-

WP-A

Step 1  
(Krok 1)

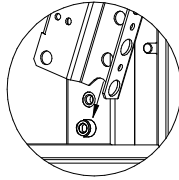
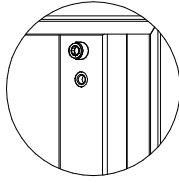
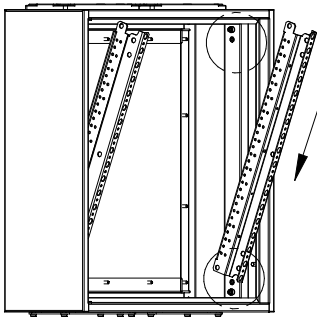

Step 2  
(Krok 2)

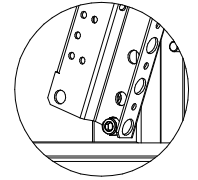
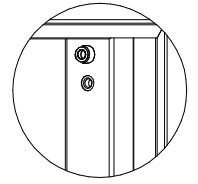
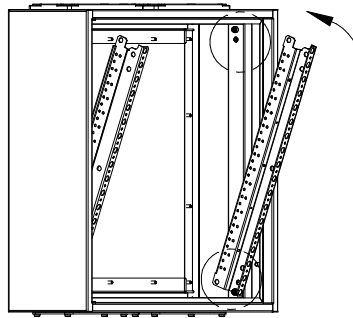

Step 3  
(Krok 3)

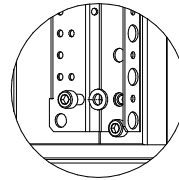
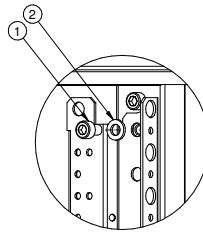
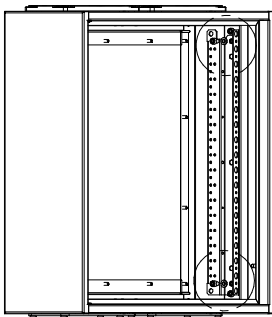

Step 4  
(Krok 4)

