

DLH US 8 H36 L335 GR V2A (204 189)

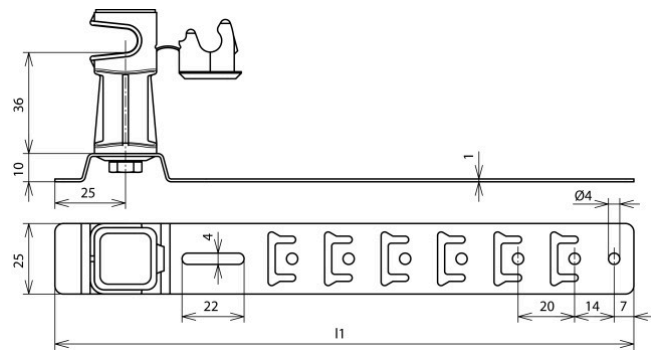

Figure without obligation



Type	DLH US 8 H36 L335 GR V2A
Part No.	204 189
Material of roof conductor holder	SiSt
Length of brace (I1)	335 mm
Height of conductor holder	36 mm
Material of conductor holder	plastic
Colour of conductor holder	grey *
Conductor support Rd	8 mm
Type of conductor holder	DEHNsnap
Conductor routing	loose
Brace type	with preformed bending points
Fixing possibilities	hook locking, angling, nailing
Type of roofing	pantiled roofs
Female thread	M6
Weight	83 g
Customs tariff number (Comb. Nomenclature EU)	85389099
GTIN	4013364042599
PU	50 pc(s)

We reserve the right to introduce changes in performance, configuration and technology, dimensions, weights and materials in the course of technical progress. The figures are shown without obligation.