

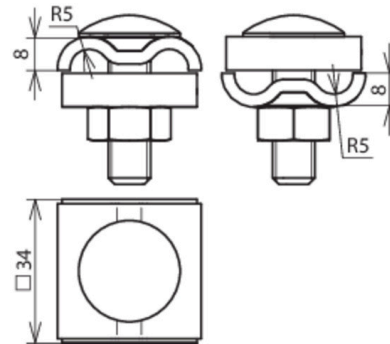

UV 8.10 KTP V2A (315 119)



Figure without obligation



Type	UV 8.10 KTP V2A
Part No.	315 119
Material of clamp	StSt
Clamping range Rd	8-10 mm
Screw	⬆ M10 x 35 mm
Material of screw / nut	StSt
Lightning current carrying capability (10/350 µs)	50 kA ^{*)}
Standard	EN 62561-1
Weight	90 g
Customs tariff number (Comb. Nomenclature EU)	85359000
GTIN	4013364134072
PU	50 pc(s)

^{*)}For exact classification, see test certificate.

We reserve the right to introduce changes in performance, configuration and technology, dimensions, weights and materials in the course of technical progress. The figures are shown without obligation.