



SPK Z 25 BRS AK1X10 2X6.8 V2A (540 210)

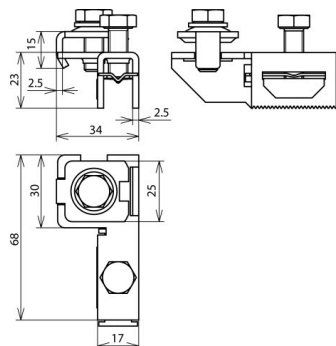

Figure without obligation

Arrangement:



Type	SPK Z 25 BRS AK1X10 2X6.8 V2A
Part No.	540 210
Material	StSt
Screw	⚙️ M8 x 20 mm
Material of screw	StSt
Connection Rd	1-2 x 6-8 mm / 1 x 10 mm
Connection (solid / stranded)	4-50 mm ²
Lightning impulse current carrying capability (10/350 µs)	50 kA ^{*)}
Standard	EN 62561-1
Weight	98 g
Customs tariff number (Comb. Nomenclature EU)	85359000
GTIN	4013364221284
PU	50 pc(s)

^{*)} For exact assignment, see test certificate.

We reserve the right to introduce changes in performance, configuration and technology, dimensions, weights and materials in the course of technical progress. The figures are shown without obligation.