

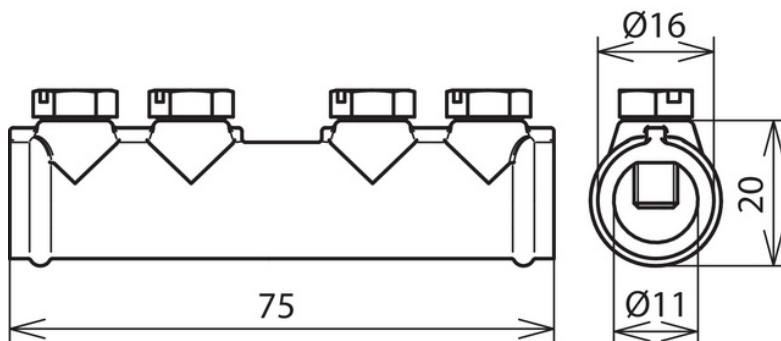

VM 7.10 SKM6X12 ZG (385 202)



Figure without obligation



Arrangement:



Type	VM 7.10 SKM6X12 ZG
Part No.	385 202
Material of clamp	ZDC
Clamping range Rd	7-10 mm
Screw	M6 x 12 mm
Material of screw	StSt
Lightning current carrying capability (10/350 µs)	^{*)}
Standard	EN 62561-1
Weight	69 g
Customs tariff number (Comb. Nomenclature EU)	85359000
GTIN	4013364068131
PU	50 pc(s)

^{*)} For exact assignment see test certificate.

We reserve the right to introduce changes in performance, configuration and technology, dimensions, weights and materials in the course of technical progress. The figures are shown without obligation.