

DLH SG 8 H20 FG180.280 CU (206 237)

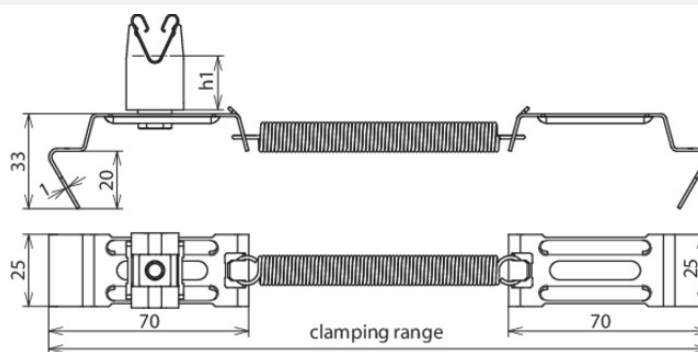

Figure without obligation



Type	DLH SG 8 H20 FG180.280 CU
Part No.	206 237
Type of roof conductor holder	SPANNgrip
Material of roof conductor holder	Cu
Clamping range of ridge tile width	180-280 mm
Height of conductor holder (h1)	20 mm
Material of conductor holder	Cu
Conductor support Rd	8 mm
Length of supporting claw	20 mm
Type of conductor holder	DEHNgrip
Conductor routing	loose
Application note	laterally adjustable conductor leading
Standard	EN 62561-4
Weight	81 g
Customs tariff number (Comb. Nomenclature EU)	85389099
GTIN	4013364077300
PU	25 pc(s)

We reserve the right to introduce changes in performance, configuration and technology, dimensions, weights and materials in the course of technical progress. The figures are shown without obligation.