

DLH SSL 8 H16 FG180.280 GR V2A (204 469)

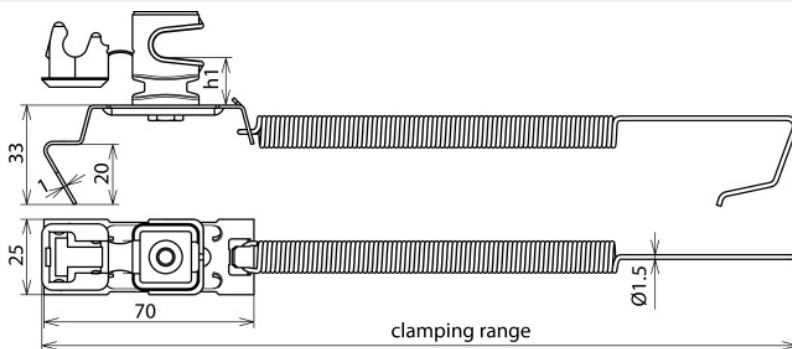

Figure without obligation



Type	DLH SSL 8 H16 FG180.280 GR V2A
Part No.	204 469
Type of roof conductor holder	SPANNsnap
Material of roof conductor holder	StSt
Clamping range of ridge tile width	180-280 mm
Height of conductor holder (h1)	16 mm
Material of conductor holder	plastic
Colour of conductor holder	grey *
Conductor support Rd	8 mm
Length of supporting claw	20 mm
Type of conductor holder	DEHNsnap
Conductor routing	loose
Application note	laterally adjustable conductor leading
Weight	63 g
Customs tariff number (Comb. Nomenclature EU)	85389099
GTIN	4013364124851
PU	25 pc(s)

We reserve the right to introduce changes in performance, configuration and technology, dimensions, weights and materials in the course of technical progress. The figures are shown without obligation.