



VK DB 20.32 8.10 FL40 BSB STBL (308 036)

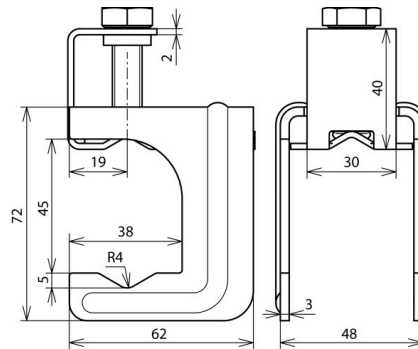

Figure without obligation



Type	VK DB 20.32 8.10 FL40 BSB STBL
Part No.	308 036
Material	St/bare
Clamping range Rd / Rd	(+//) 20-32 / 8-10 mm
Clamping range Rd / FI	(+//) 20-32 / 40 x 4-5 mm
Screw	M10 x 35 mm
Material of screw	St/bare
Short-circuit current (a.c. 50 Hz / d.c.) (1 s; ≤ 300 °C)	14.0 kA
Lightning current carrying capability (10/350 μs)	^{*)}
Standard	EN 62561-1
Weight	266 g
Customs tariff number (Comb. Nomenclature EU)	85359000
GTIN	4013364136588
PU	25 pc(s)

^{*)} For exact assignment see test certificate.

We reserve the right to introduce changes in performance, configuration and technology, dimensions, weights and materials in the course of technical progress. The figures are shown without obligation.