

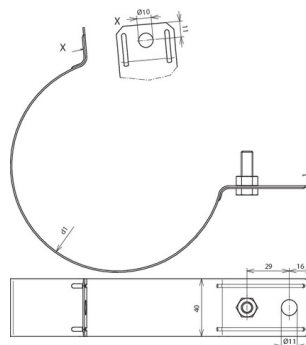

RRS 120 B11 STTZN (420 120)



Figure without obligation



Arrangement:

Type	RRS 120 B11 STTZN
Part No.	420 120
Material	St/tZn
Clamping range pipe Ø (d1)	120 mm
Hole Ø	11 mm
Screw	☛ M8 x 25 mm
Material of screw / nut	StSt
Lightning current carrying capability (10/350 µs)	☛ 100 kA *)
Standard	EN 62561-1
Weight	160 g
Customs tariff number (Comb. Nomenclature EU)	85359000
GTIN	4013364022829
PU	1 pc(s)

*) For exact assignment, see test certificate.

We reserve the right to introduce changes in performance, configuration and technology, dimensions, weights and materials in the course of technical progress. The figures are shown without obligation.