

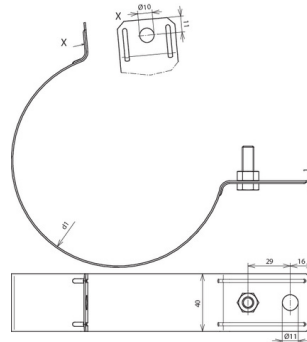

**RRS 100 B11 STTZN (420 100)**



Figure without obligation



Arrangement:

Type	RRS 100 B11 STTZN
Part No.	420 100
Material	St/tZn
Clamping range pipe Ø (d1)	100 mm
Hole Ø	11 mm
Screw	☐ M8 x 25 mm
Material of screw / nut	StSt
Lightning current carrying capability (10/350 µs)	☐ 100 kA *)
Standard	EN 62561-1
Weight	137 g
Customs tariff number (Comb. Nomenclature EU)	85359000
GTIN	4013364022805
PU	50 pc(s)

\*) For exact assignment, see test certificate.

We reserve the right to introduce changes in performance, configuration and technology, dimensions, weights and materials in the course of technical progress. The figures are shown without obligation.