

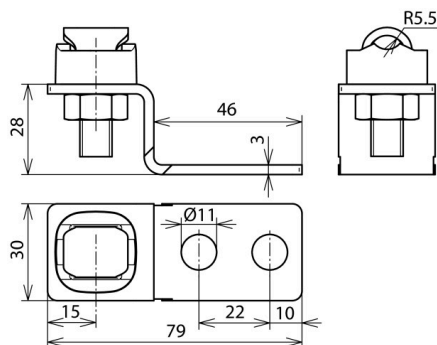

ES ZF 2XB11 KSV 7.10 STTZN (363 010)



Figure without obligation



Arrangement:

Type	ES ZF 2XB11 KSV 7.10 STTZN
Part No.	363 010
Material	St/tZn
Distance of holes	22 mm
Hole Ø	11 mm
Clamping range Rd	7-10 mm
Type	cranked with KS connector (Part No. 301000)
Lightning current carrying capability (10/350 µs)	50 kA ^{*)}
Standard	EN 62561-1
Weight	124 g
Customs tariff number (Comb. Nomenclature EU)	85359000
GTIN	4013364045743
PU	50 pc(s)

^{*)} For exact assignment, see test certificate.

We reserve the right to introduce changes in performance, configuration and technology, dimensions, weights and materials in the course of technical progress. The figures are shown without obligation.