

SKS M16X30 V2A (561 931)



Figure without obligation

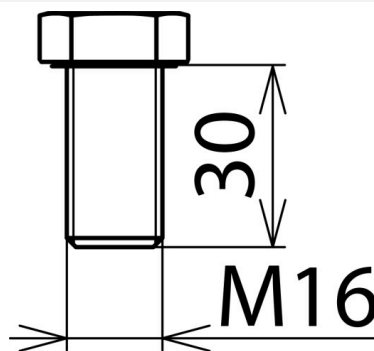

Figure without obligation

Type	SKS M16X30 V2A
Part No.	561 931
Dimensions	M16 x 30 mm
Material	StSt A2-70
Standard	In accordance with DIN 933
Weight	77 g
Customs tariff number (Comb. Nomenclature EU)	73181575
GTIN	4013364053311
PU	1 pc(s)

We reserve the right to introduce changes in performance, configuration and technology, dimensions, weights and materials in the course of technical progress. The figures are shown without obligation.