

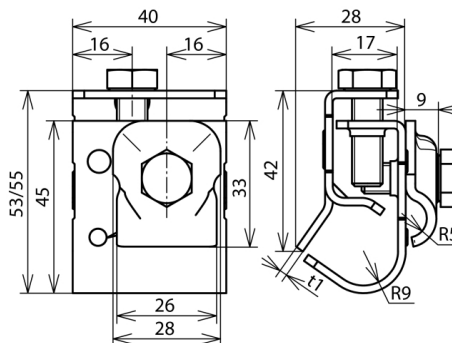

DRK KB 6.10 W16.22 CU (339 067)



Figure without obligation



Arrangement:

Type	DRK KB 6.10 W16.22 CU
Part No.	339 067
Component protection	German Patent No. P 38 35 245.1
Clamping range bead	16-22 mm
Material of gutter clamp	Cu
Clamping range Rd	6-10 mm
Material of conductor clamp	Cu
Width / material thickness	40 / 2 mm
Screw	☐ M8 x 20 / 25 mm
Material of screw	StSt
Lightning current carrying capability (10/350 μs)	100kA ^{*)}
Standard	EN 62561-1
Weight	136 g
Customs tariff number (Comb. Nomenclature EU)	85359000
GTIN	4013364046887
PU	25 pc(s)

^{*)} See test certificate for exact classification.

We reserve the right to introduce changes in performance, configuration and technology, dimensions, weights and materials in the course of technical progress. The figures are shown without obligation.