

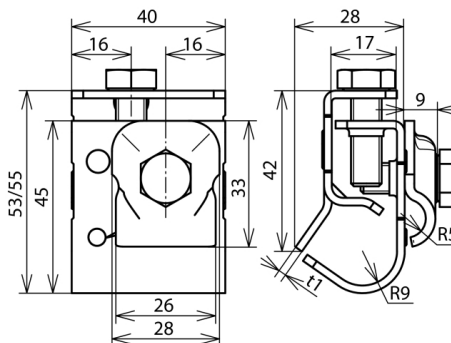

DRK KB 6.10 W16.22 AL (339 061)



Figure without obligation



Arrangement:

Type	DRK KB 6.10 W16.22 AL
Part No.	339 061
Component protection	German Patent No. P 38 35 245.1
Clamping range bead	16-22 mm
Material of gutter clamp	Al
Clamping range Rd	6-10 mm
Material of conductor clamp	Al
Width / material thickness	40 / 3 mm
Screw	☒ M8 x 20 / 25 mm
Material of screw	StSt
Standard	EN 62561-1
Weight	83 g
Customs tariff number (Comb. Nomenclature EU)	85359000
GTIN	4013364127395
PU	25 pc(s)

*) See test certificate for exact classification.

We reserve the right to introduce changes in performance, configuration and technology, dimensions, weights and materials in the course of technical progress. The figures are shown without obligation.