



**AL ZF DUL 6.10 B5.2 6.5 L81 AL (377 200)**

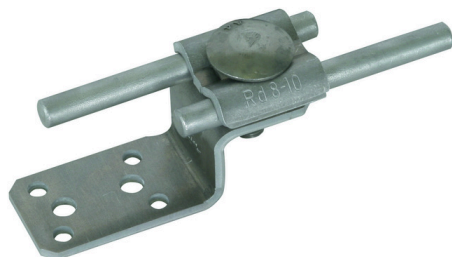
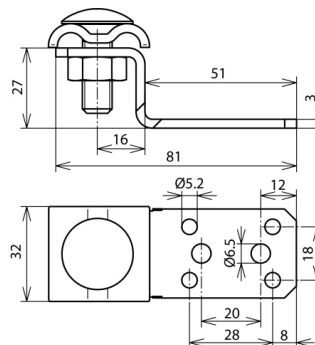

Figure without obligation



Arrangement:

Type	AL ZF DUL 6.10 B5.2 6.5 L81 AL
Part No.	377 200
Material of bracket	Al
Material thickness (t1)	3 mm
Fixing	[4x] Ø5.2 / [2x] Ø6.5 mm
Fixing possibility	blind rivets or drilling screws
Application note	according to EN 62305-3 Suppl. 1 4 rivets Ø5mm, 2 rivets Ø6mm shall be used to connect materials ≥ 0.5mm thick or 2 Parker screws StSt Ø6.3mm for materials ≥ 2mm thick.
Material of double clamp	Al
Screw	M10 x 30 mm
Material of screw / nut	StSt
Connection	lengthwise / crosswise
Connection with	double cleat
Clamping range Rd	8-10 mm
Lightning current carrying capability (10/350 µs)	50 kA *)
Standard	EN 62561-1
Weight	70 g
Customs tariff number (Comb. Nomenclature EU)	85359000
GTIN	4013364136465
PU	50 pc(s)

\*) For exact assignment, see test certificate.

We reserve the right to introduce changes in performance, configuration and technology, dimensions, weights and materials in the course of technical progress. The figures are shown without obligation.