

DLH DS 8 H16 FG180.280 GR V2A (204 109)

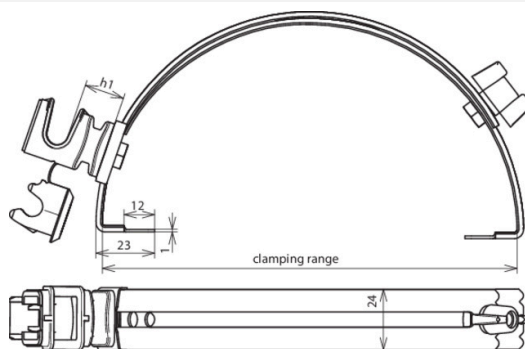

Figure without obligation



Type	DLH DS 8 H16 FG180.280 GR V2A
Part No.	204 109
Material of roof conductor holder	SiSt
Clamping range	180-280 mm
Height of conductor holder (h1)	16 mm
Material of conductor holder	plastic
Colour of conductor holder	grey °
Conductor support Rd	8 mm
Length of clamping claw	23 mm
Type of conductor holder	DEHNsnap
Conductor routing	loose
Application note	conductor leading (support) laterally adjustable
Female thread	M6
Weight	98 g
Customs tariff number (Comb. Nomenclature EU)	85389099
GTIN	4013364028098
PU	25 pc(s)

We reserve the right to introduce changes in performance, configuration and technology, dimensions, weights and materials in the course of technical progress. The figures are shown without obligation.