



KS 7.10 7.10 FL40 ZP V4A (319 229)

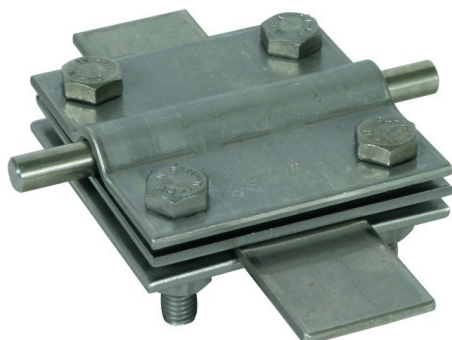
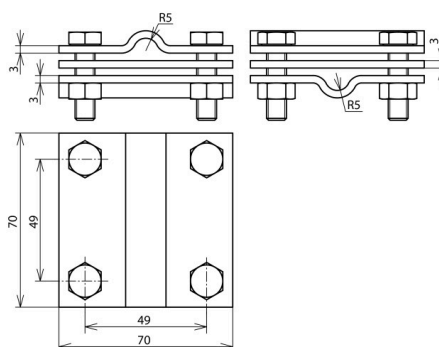

Figure without obligation



Type	KS 7.10 7.10 FL40 ZP V4A
Part No.	319 229
Material of clamp	StSt (V4A)
Clamping range Rd / Rd	7-10 / 7-10 mm
Clamping range Rd / FI	7-10 / 30-40 mm
Clamping range FI / FI	30-40 / 30-40 mm
Clamping range (stranded / cable)	35-70 mm ²
Screw	M8 x 30 mm
Material of screw / nut	StSt (V4A)
Material No.	1.4571 / 1.4404 / 1.4401
ASTM / AISI:	316Ti / 316L / 316
Dimensions	70 x 70 x 3 mm
Intermediate plate	yes
Lightning current carrying capability (10/350 µs)	^{*)}
Standard	EN 62561-1
Short-circuit current (AC 50 Hz / DC) (1 s; ≤ 300 °C)	5.0 kA
Weight	409 g
Customs tariff number (Comb. Nomenclature EU)	85359000
GTIN	4013364108752
PU	25 pc(s)

^{*)} See test certificate for exact classification.

We reserve the right to introduce changes in performance, configuration and technology, dimensions, weights and materials in the course of technical progress. The figures are shown without obligation.