

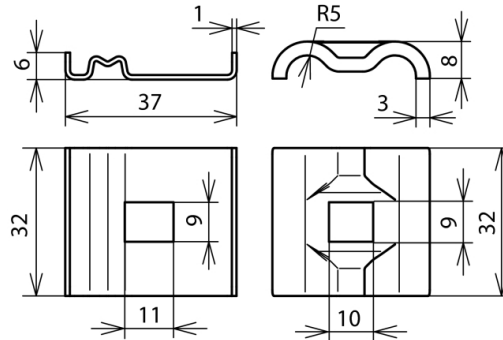

KP AQ4 50 DUL 8.10 VKL9 V2A (540 251)



Figure without obligation



Earthing clamps for integrating mounting systems, e.g. of PV installations in the functional equipotential bonding/functional earthing (black conductor possible) and lightning equipotential bonding according to IEC/EN 62305-3.

The StSt contact plate (intermediate element) allows different conductor materials (Cu, Al, St/tZn and StSt) to be connected to the normal mounting systems, e.g. to aluminium, without the risk of contact corrosion.

The double clamp design allows easy and quick interconnection of the profiles, e.g. by feed-through wiring.

Type	KP AQ4 50 DUL 8.10 VKL9 V2A
Part No.	540 251
Material of clamp	StSt
Clamping range Rd	8-10 mm
Connection (solid / stranded)	4-50 mm ²
Weight	37 g
Customs tariff number (Comb. Nomenclature EU)	85359000
GTIN	4013364138674
PU	100 pc(s)

We reserve the right to introduce changes in performance, configuration and technology, dimensions, weights and materials in the course of technical progress. The figures are shown without obligation.