

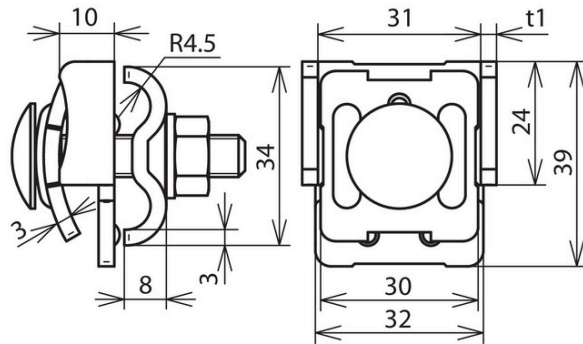

FK DUL 6.10 KBF0.7 8 V2A (365 019)



Figure without obligation



Arrangement:

Type	FK DUL 6.10 KBF0.7 8 V2A
Part No.	365 019
Clamping range of seam	0.7-8 mm
Material of clamp	StSt
Material thickness (t1)	2.5 mm
Clamping range Rd	8-10 mm
Screw	⬆ M8 x 40 mm
Material of screw / nut	StSt
Lightning current carrying capability (10/350 µs)	50 kA ^{*)}
Standard	EN 62561-1
Weight	83 g
Customs tariff number (Comb. Nomenclature EU)	85359000
GTIN	4013364096295
PU	50 pc(s)

^{*)} For exact assignment see test certificate.

We reserve the right to introduce changes in performance, configuration and technology, dimensions, weights and materials in the course of technical progress. The figures are shown without obligation.