

ES 2X3 ASB11 V2A (472 119)

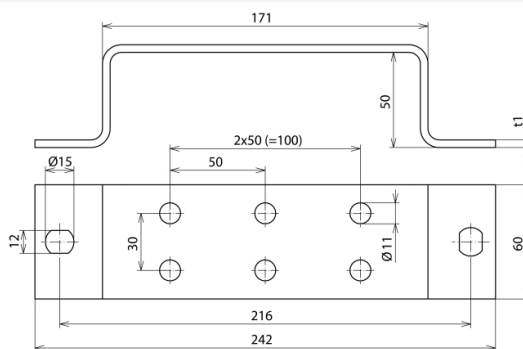

Figure without obligation



Type	ES 2X3 ASB11 V2A
Part No.	472 119
Material	StSt
Cross-section	300 mm ²
Connection bores Ø	11 mm
Dimension s (l x w x d1)	242 x 60 x 5 mm
Fixing	[2x] 12 x 15 mm
Standard	EN 62561-1
Weight	740 g
Customs tariff number (Comb. Nomenclature EU)	85369010
GTIN	4013364074484
PU	1 pc(s)

*) For exact assignment see test certificate.

We reserve the right to introduce changes in performance, configuration and technology, dimensions, weights and materials in the course of technical progress. The figures are shown without obligation.

Special designs available on request.