

EFK FL30 SKN (792 030)

- Earthing and short-circuiting devices can be configured online via the earthing and short-circuiting configurator



Figure without obligation

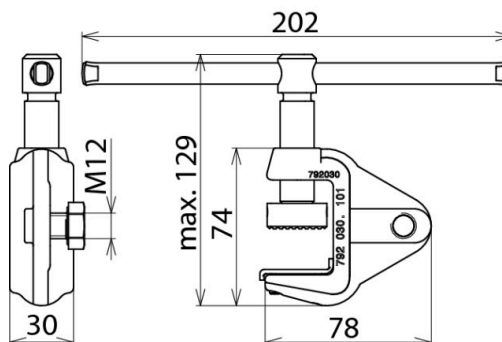

Figure without obligation

Type	EFK FL30 SKN
Part No.	792 030
Clamping range	Up to 30 mm
Anti-rotation cable lug	PK1
For cable cross-section Cu	16 ... 50 mm ²
Max. short-circuit current I _k 0.5 s	14.0 kA
Max. short-circuit current I _k 1 s	9.9 kA
Standard	EN/IEC 61230 (DIN VDE 0683-100)
Temperature range	-25 °C ... +55 °C
Material (clamp body)	MCl/gal Zn
Material (shaft)	Brass/gal Zn
Material (milling plate)	Hardened/nikel-plated steel
Material (spring)	Spring steel
Weight	610 g
Customs tariff number (Comb. Nomenclature EU)	85359000
GTIN	4013364005853
PU	1 pc(s)

We reserve the right to introduce changes in performance, configuration and technology, dimensions, weights and materials in the course of technical progress. The figures are shown without obligation.

The clamps must have the same maximum short-circuit current as the earthing and short-circuiting cables!