

EFK FL40 SKN (792 190)

- Earthing and short-circuiting devices can be configured online via the earthing and short-circuiting configurator



Figure without obligation

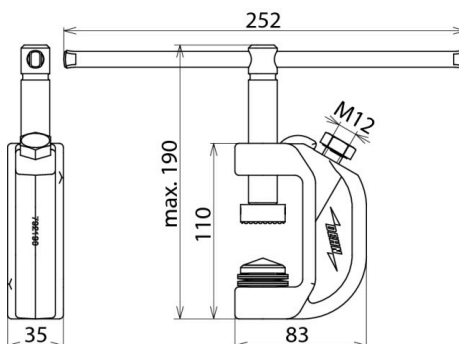

Figure without obligation

Type	EFK FL40 SKN
Part No.	792 190
Clamping range	up to 40 mm
Anti-rotation cable lug	PK1
For cable cross-section Cu	16 ... 95 mm ²
Max. short-circuit current I _k 0.5 s	26.5 kA
Max. short-circuit current I _k 1 s	18.7 kA
Standard	EN/IEC 61230 (DIN VDE 0683-100)
Temperature range	-25 °C ... +55 °C
Material (clamp body)	MCl/gal Zn
Material (shaft)	Brass/gal Zn
Material (milling plate)	Hardened/nikel-plated steel
Material (spring)	Spring steel
Weight	1,22 kg
Customs tariff number (Comb. Nomenclature EU)	85359000
GTIN	4013364068315
PU	1 pc(s)

We reserve the right to introduce changes in performance, configuration and technology, dimensions, weights and materials in the course of technical progress. The figures are shown without obligation.

The clamps must have the same maximum short-circuit current as the earthing and short-circuiting cables!