

EAS EK FM 16 (775 631)

- Earthing and short-circuiting devices can be configured online via the earthing and short-circuiting configurator



Figure without obligation

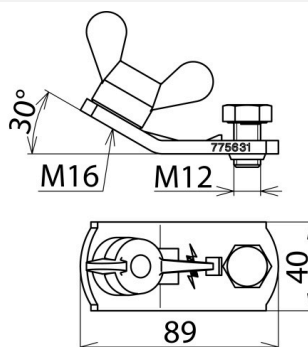

Figure without obligation

Type	EAS EK FM 16
Part No.	775 631
Dimensions	M16
Anti-rotation cable lug	PK1
For cable cross-section Cu	16 ... 150 mm ²
Max. short-circuit current I _k 0.5 s	42.0 kA
Max. short-circuit current I _k 1 s	29.6 kA
Standard	EN/IEC 61230 (DIN VDE 0683-100)
Temperature range	-25 °C ... +55 °C
Material (terminal lug)	E-Cu/gal Sn
Material (wing nut)	Cu alloy/gal Sn
Weight	290 g
Customs tariff number (Comb. Nomenclature EU)	85359000
GTIN	4013364102552
PU	1 pc(s)

We reserve the right to introduce changes in performance, configuration and technology, dimensions, weights and materials in the course of technical progress. The figures are shown without obligation.

The clamps must have the same maximum short-circuit current as the earthing and short-circuiting cables!