

EAS EK FM 12 (775 621)

- Earthing and short-circuiting devices can be configured online via the earthing and short-circuiting configurator



Figure without obligation

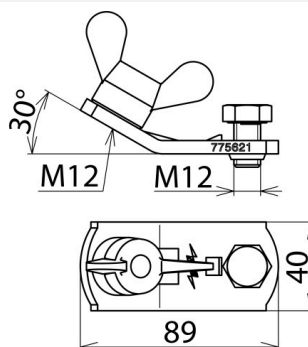

Figure without obligation

Type	EAS EK FM 12
Part No.	775 621
Dimensions	M12
Anti-rotation cable lug	PK1
For cable cross-section Cu	16 ... 150 mm ²
Max. short-circuit current I _k 0.5 s	42.0 kA
Max. short-circuit current I _k 1 s	29.6 kA
Standard	EN/IEC 61230 (DIN VDE 0683-100)
Temperature range	-25 °C ... +55 °C
Material (terminal lug)	E-Cu/gal Sn
Material (wing nut)	Cu alloy/gal Sn
Weight	311 g
Customs tariff number (Comb. Nomenclature EU)	85359000
GTIN	4013364102545
PU	1 pc(s)

We reserve the right to introduce changes in performance, configuration and technology, dimensions, weights and materials in the course of technical progress. The figures are shown without obligation.

The clamps must have the same maximum short-circuit current as the earthing and short-circuiting cables!