

EAP 25 SIT US OL (728 503)

- For connecting single-pole earthing and short-circuiting devices to transformers of overhead contact line masts or to fuse holders

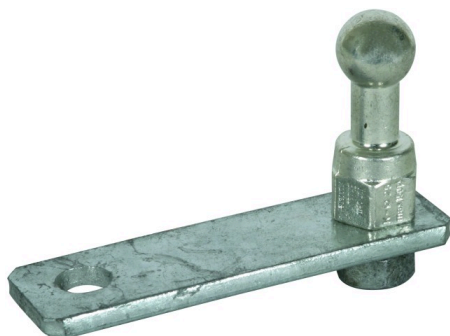

Figure without obligation

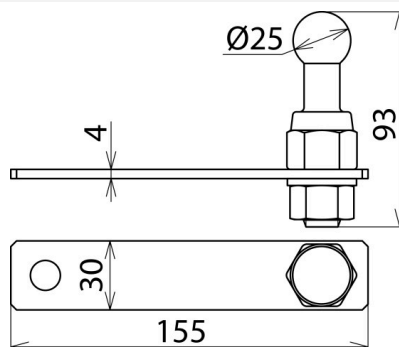

Figure without obligation

Type	EAP 25 SIT US OL
Part No.	728 503
Fixed point Ø	25 mm
Dimension	155 x 30 x 4 mm
DB drawing No.	4 Ebgw 01.60
DB material No.	157 545
Standard	EN/IEC 61230 (DIN VDE 0683-100) and DIN 48088-1
Material (terminal lug)	E-Cu/gal Sn
Material (fixed point)	E-Cu/gal Sn
Material (threaded pin)	StSt A2-70
Weight	453 g
Customs tariff number (Comb. Nomenclature EU)	85359000
GTIN	4013364079564
PU	1 pc(s)

We reserve the right to introduce changes in performance, configuration and technology, dimensions, weights and materials in the course of technical progress. The figures are shown without obligation.