

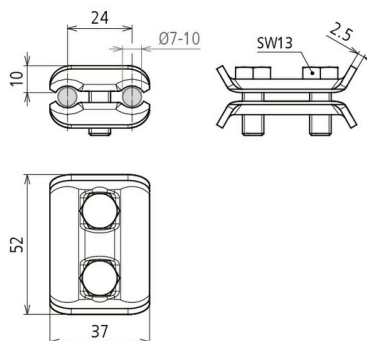

PV 7.10 SKM8X20 STTZN (307 000)



Figure without obligation



Arrangement:

Type	PV 7.10 SKM8X20 STTZN
Part No.	307 000
Material of clamp	St/tZn
Clamping range Rd / Rd	7-10 mm
Screw	● M8 x 20 mm
Material of screw / nut	St/tZn
Lightning current carrying capability (10/350 µs)	100kA ^{*)}
Standard	EN 62561-1
Weight	105 g
Customs tariff number (Comb. Nomenclature EU)	85359000
Stock No.	5999-12-158-2303
GTIN	4013364024151
PU	50 pc(s)

^{*)}For exact classification, see test certificate.

We reserve the right to introduce changes in performance, configuration and technology, dimensions, weights and materials in the course of technical progress. The figures are shown without obligation.