

LH DG 8 H20 IGM6 V2A (207 019)

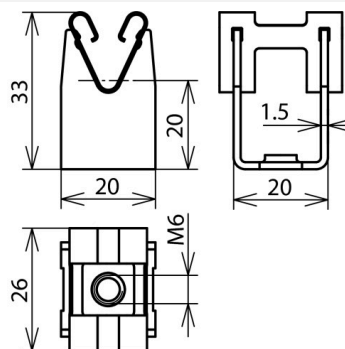

Figure without obligation



Type	LH DG 8 H20 IGM6 V2A
Part No.	207 019
Height of conductor holder	20 mm
Thread of conductor holder	M6
Material of conductor holder	StSt
Conductor support Rd	8 mm
Conductor routing	loose
Standard	EN 62561-4
Weight	20 g
Customs tariff number (Comb. Nomenclature EU)	85389099
GTIN	4013364054912
PU	50 pc(s)

We reserve the right to introduce changes in performance, configuration and technology, dimensions, weights and materials in the course of technical progress. The figures are shown without obligation.