



ERS 42 AB11 STTZN (410 114)

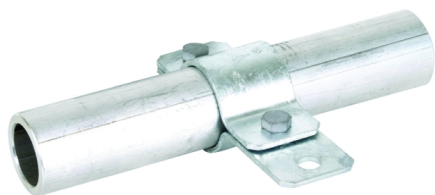
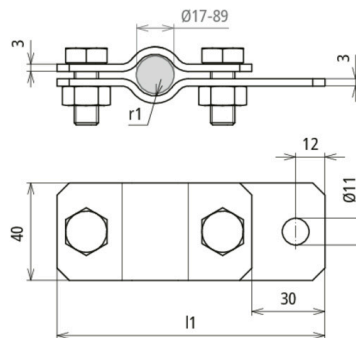

Figure without obligation



Arrangement:

Type	ERS 42 AB11 STTZN
Part No.	410 114
Clamping range pipe Ø	42 mm
Material	St/tZn
Screw	⚙ M8 x 20 mm
Material of screw / nut	St/tZn
Dimensions (l1 x r1)	132.5 x 21 mm
Lightning current carrying capability (10/350 µs)	100kA ^{*)}
Standard	EN 62561-1
Weight	276 g
Customs tariff number (Comb. Nomenclature EU)	85359000
GTIN	4013364026261
PU	25 pc(s)

^{*)} For exact assignment, see test certificate.

We reserve the right to introduce changes in performance, configuration and technology, dimensions, weights and materials in the course of technical progress. The figures are shown without obligation.