



ERS 21 AB11 STTZN (410 012)

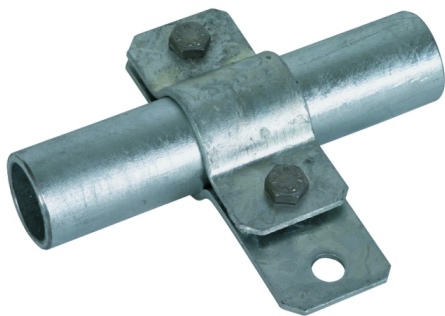
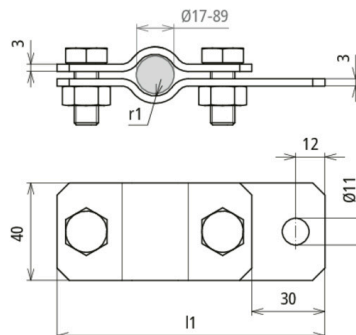

Figure without obligation



Arrangement:

Type	ERS 21 AB11 STTZN
Part No.	410 012
Clamping range pipe Ø	21 mm
Material	St/tZn
Screw	M10 x 25 mm
Material of screw / nut	St/tZn
Dimensions (l1 x r1)	115 x 10.5 mm
Lightning current carrying capability (10/350 µs)	100 kA ^{*)}
Standard	EN 62561-1
Weight	234 g
Customs tariff number (Comb. Nomenclature EU)	85359000
GTIN	4013364026186
PU	25 pc(s)

^{*)} For exact assignment, see test certificate.

We reserve the right to introduce changes in performance, configuration and technology, dimensions, weights and materials in the course of technical progress. The figures are shown without obligation.