

CP X-1 M

for **MODULAR DIN-RAIL DEVICES**
(osłony modułowe)

- Mounting instructions
- Montageanleitung
- Navodilo za montažo
- Instrukcje montażu
- Upute za montažu
- Montážní návod
- Navod na montáž
- Szerelési utmutató
- Montavimo instrukcija
- Инструкция за монтаж
- Montāžas instrukcija
- Paigaldusjuhend

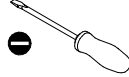
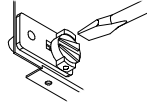

Screwdriver flat-blade
(Wkrętarz płaski)

CP 1-1 M 001101451



CP 2.2-1 M 001101454

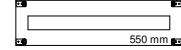

CP 1.4-1 M 001101452

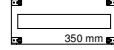

CP 3-1 M 001101455

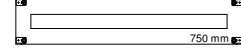

CP 2-1 M 001101453

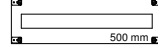

CP 3.8-1 M 001101456

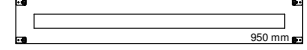

Position 1

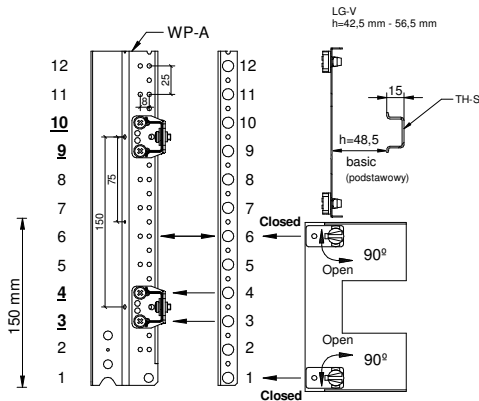

Position 2

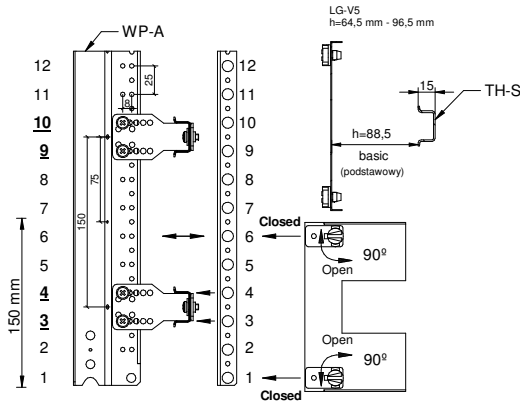

Position 3

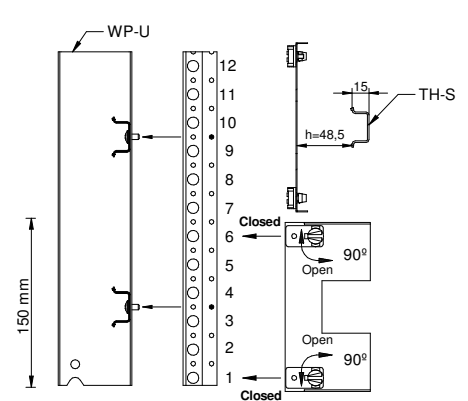

CP X-1 M

for **MODULAR DIN-RAIL DEVICES**
(osłony modułowe)

- Mounting instructions
- Montageanleitung
- Navodilo za montažo
- Instrukcje montażu
- Upute za montažu
- Montážní návod
- Navod na montáž
- Szerelési utmutató
- Montavimo instrukcija
- Инструкция за монтаж
- Montāžas instrukcija
- Paigaldusjuhend

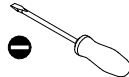
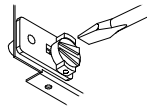

Screwdriver flat-blade
(Wkrętarz płaski)

CP 1-1 M 001101451



CP 2.2-1 M 001101454

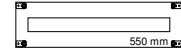

CP 1.4-1 M 001101452

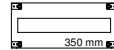

CP 3-1 M 001101455

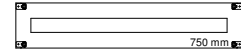

CP 2-1 M 001101453

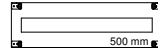

CP 3.8-1 M 001101456

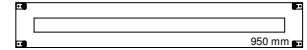

Position 1

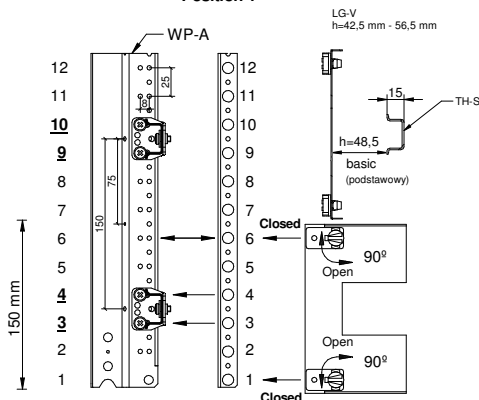

Position 2

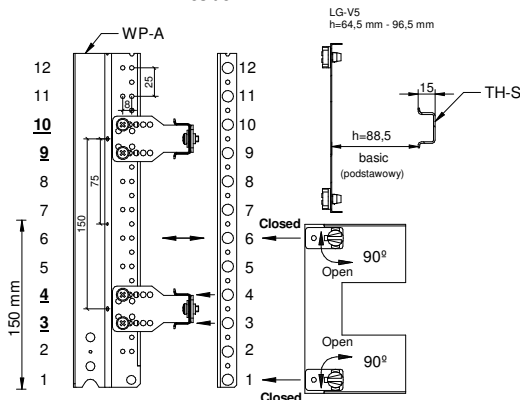

Position 3

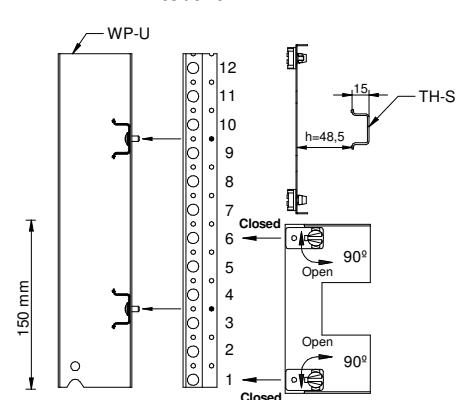

CP X-1 M

Position 1 - support WP-A			
No.	Type ETI	Name	Pcs.
1	LG-V	Support	2
2	AST 4.8x9.5	Tapping screw	4
3	AW-RE 5	Washer M5 DIN9021 Zn	2
4	AS-C 5x10	Screw M5x10 DIN7985 Zn	2

Position 2 - support WP-A			
No.	Type ETI	Name	Pcs.
1	LG-V5	Support	2
2	AST 4.8x9.5	Tapping screw	4
3	AW-RE 5	Washer M5 DIN9021 Zn	2
4	AS-C 5x10	Screw M5x10 DIN7985 Zn	2

Position 3 - support WP-U			
No.	Type ETI	Name	Pcs.
1	AST 4.8x9.5	Tapping screw	2

Position 1

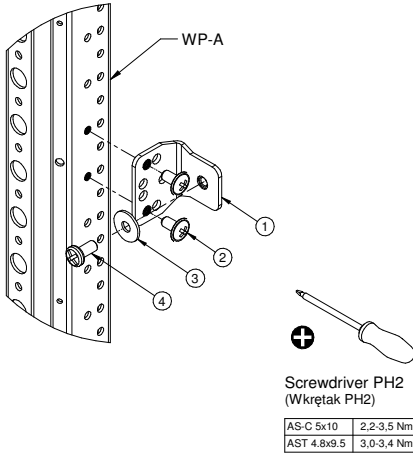

Position 2

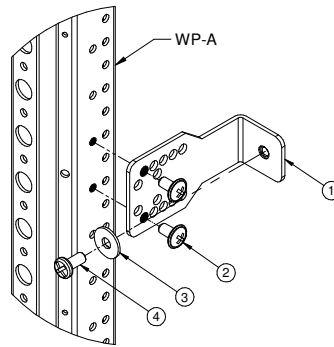

Position 3

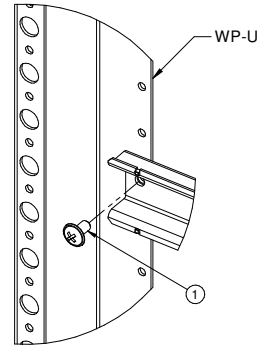

CP X-1 M

Position 1 - support WP-A			
No.	Type ETI	Name	Pcs.
1	LG-V	Support	2
2	AST 4.8x9.5	Tapping screw	4
3	AW-RE 5	Washer M5 DIN9021 Zn	2
4	AS-C 5x10	Screw M5x10 DIN7985 Zn	2

Position 2 - support WP-A			
No.	Type ETI	Name	Pcs.
1	LG-V5	Support	2
2	AST 4.8x9.5	Tapping screw	4
3	AW-RE 5	Washer M5 DIN9021 Zn	2
4	AS-C 5x10	Screw M5x10 DIN7985 Zn	2

Position 3 - support WP-U			
No.	Type ETI	Name	Pcs.
1	AST 4.8x9.5	Tapping screw	2

Position 1

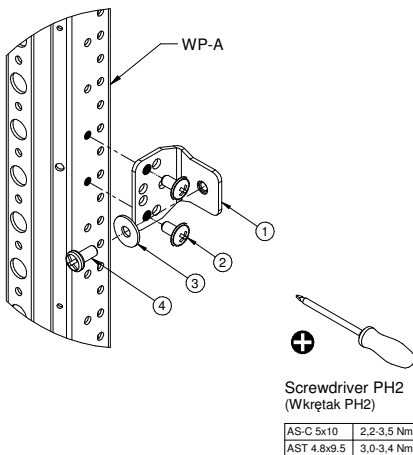

Position 2

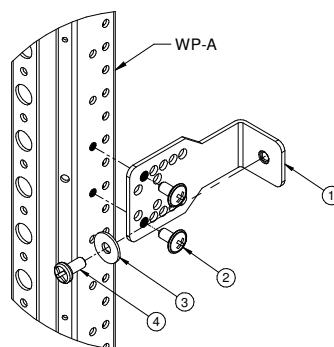

Position 3

