

wymiary w [mm]

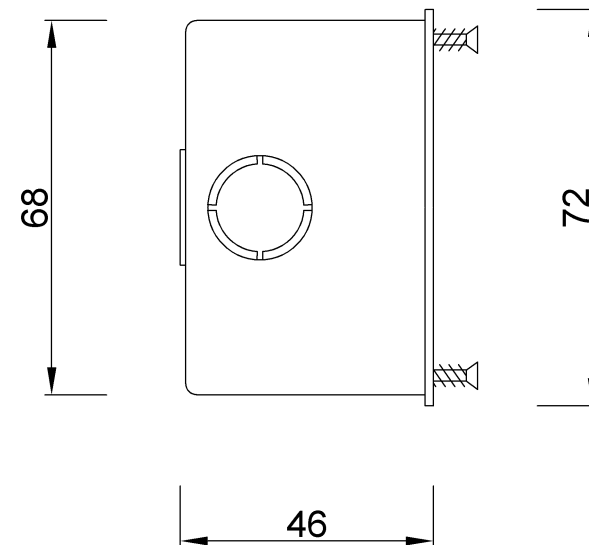
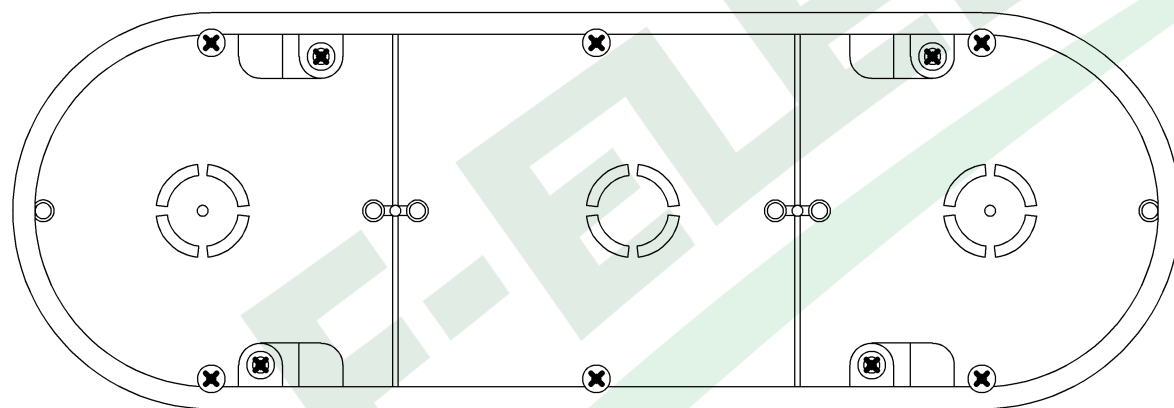
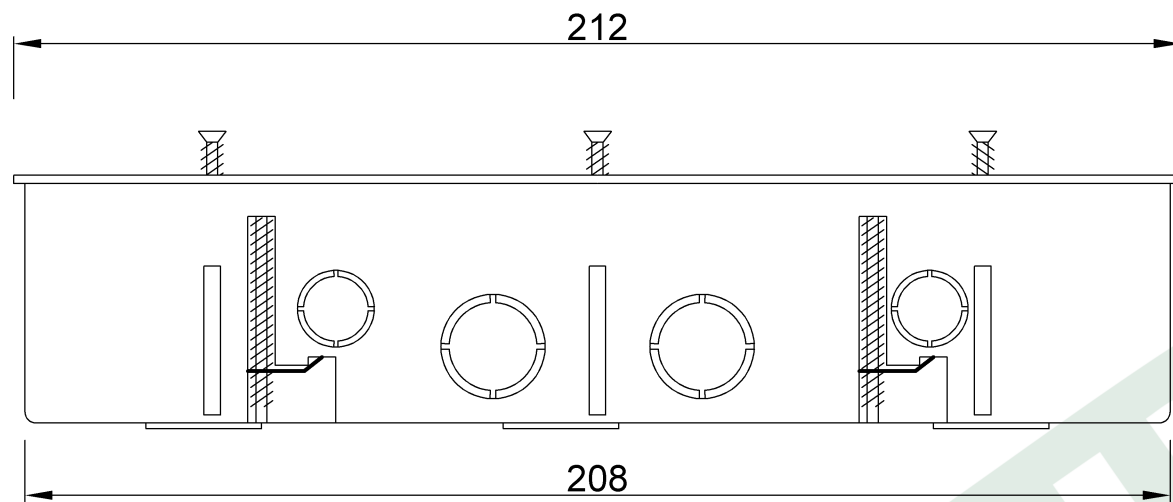

F1.0011 Puszka końcowa 3x60 do płyt gipsowych

F-ELEKTRO

www.f-elektro.com,

e-mail: info@f-elektro.com