

TV-DATA FINAL ANTENNA SOCKET

type **BMAD1../..**
DAD1../..

Product marking:

BMAD1../..
DAD1../..

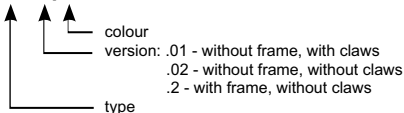

Application

- Multimedia sockets of the **BMAD1../..**, **DAD1../..** series are intended to be used for cable TV systems in which the return channel is used for data transmission, Internet and VoIP services.
- Ensures the division of signal into TV and DATA signals.
- One input socket for the coaxial cable providing signal in the range 5 + 1000 MHz.
- Two output sockets F-type for the data transmission and TV receiver.
- Full frequency response in individual bands.
- High isolation between individual sockets.

ISO 9001:2008 QMS

KONTAKT SIMON

43-500 Czechowice-Dziedzice
ul. Bestwińska 21
POLAND
tel. +48 32 324 63 00
fax +48 32 215 35 55
www.kontakt-simon.com.pl
e-mail: info@kontakt-simon.com.pl

Technical data

Input line frequency range	5 + 1000 MHz
TV line frequency range	88 + 1000 MHz
DATA line frequency range	5 + 1000 MHz
Attenuation in the DATA line	2,8 + 3,9 dB
Attenuation in the TV line	3,75 + 4,8 dB

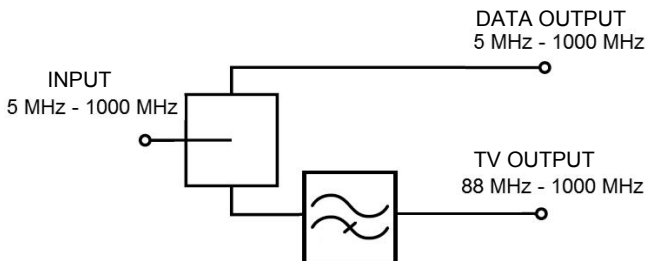
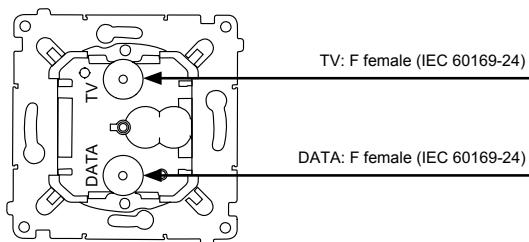

INSTALLATION INTRUCTIONS

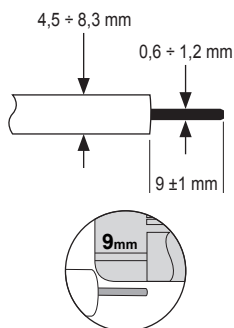

1. Prepare the ending of antenna cable for connection - strip the insulation of the coaxial cable by cutting off the external insulation, braid and internal insulation at the same length - according to marker on the housing.

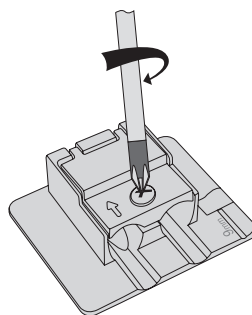

2. Lose the set screw.

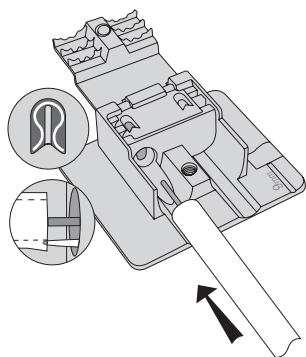

3. Insert the antenna cable to the socket clamp, paying attention for placing of blade between external insulation and braid. Check correctness of cable core placing in the terminal.

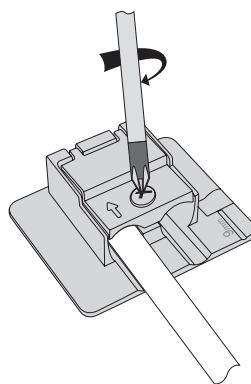

4. Tight the set screw.

5. Insert the socket to a Ø60 mm installation box and fix with clamps or fixing bolts depending on type of the box.

6. Install the frame and cover on the body of the socket body.