



Parametry podstawowe

Gama produktów	Harmony XB5
Typ produktu lub komponentu	Główka przełącznika podświetlanego
Zgodność produktu	Universal LED
Skrócona nazwa urządzenia	ZB5
Materiał maskownicy	Dark grey plastic
Średnica montażowa	22 mm
Typ głowicy	Standard
Sprzedaż zgodnie z niepodzielną liczbą	1
Kształt główki elementu sygnalizacyjnego	Okrągły
Typ elementu napędowego	Do środka Samoczynny powrót
Rodzaj elementu napędowego	Czerwony Standardowe pokrętko
Położenie elementu napędowego	3 pozycje +/- 45°

Parametry uzupełniające

CAD szerokość całkowita	29 mm
CAD wysokość całkowita	29 mm
CAD głębokość całkowita	43 mm
Masa produktu	0,016 kg
Trwałość mechaniczna	500000 cykl
Nazwa stacji	XALD 1...5 wycięcia XALK 2...5 wycięcia
Kod składu elektrycznego	M3 dla <4 zestyki z użyciem pojedynczy bloki w montaż z przodu z Zintegrowany LED M6 dla <2 zestyki z użyciem pojedynczy bloki w montaż z przodu z wbudowany LED i transformator M10 dla <2 zestyki z użyciem pojedynczy bloki w montaż z przodu z Zintegrowany LED MF1 dla <2 zestyki z użyciem pojedynczy bloki w montaż z przodu z Zintegrowany LED MR1 dla <2 zestyki z użyciem pojedynczy bloki w montaż z tyłu z Zintegrowany LED M4 dla <4 zestyki z użyciem pojedyncze lub podwójne bloki w montaż z przodu z Zintegrowany LED
Prezentacja urządzenia	Podstawowy element

Środowisko pracy

Pokrycie ochronne	TH
Temperatura otoczenia dla przechowywania	-40...70 °C
Temperatura otoczenia dla pracy urządzenia	-40...70 °C
Kategoria przepięć	Klasa 2 zgodnie z IEC 60536
Stopień ochrony IP	IP66 zgodnie z IEC 60529 IP67 IP69 IP69K

Stopień ochrony NEMA	NEMA 13 NEMA 4X
Odporność na myjkę wysokociśnieniową	7000000 Pa w 55 °C, odległość: 0.1 m
Stopień ochrony IK	IK04 zgodnie z IEC 50102
Normy	EN/IEC 60947-5-1 EN/IEC 60947-5-5 CSA C22.2 Nr 14 EN/IEC 60947-1 EN/IEC 60947-5-4 JIS C8201-5-1 UL 508 JIS C8201-1
Certyfikaty produktu	CSA[RETURN]GL[RETURN]DNV[RETURN]LROS (Lloyds register of shipping) [RETURN]BV[RETURN]z certyfikatem UL
Odporność na wibracje	5 gn (f= 2...500 Hz) zgodnie z IEC 60068-2-6
Odporność na wstrząsy	30 gn (czas trwania = 18 ms) dla przyspieszenie półfali sinusoidy zgodnie z IEC 60068-2-27 50 gn (czas trwania = 11 ms) dla przyspieszenie półfali sinusoidy zgodnie z IEC 60068-2-27

Jednostka opakowania

Jednostka miary opakowania 1	PCE
Ilość jednostek w opakowaniu 1	1
Wysokość opakowania 1	5,6 cm
Szerokość opakowania 1	3,4 cm
Długość opakowania 1	5,4 cm
Waga opakowania 1	21,0 g
Jednostka miary opakowania 2	S02
Ilość jednostek w opakowaniu 2	50
Wysokość opakowania 2	15,0 cm
Szerokość opakowania 2	30,0 cm
Długość opakowania 2	40,0 cm
Waga opakowania 2	1,605 kg

Oferta zrównoważonego rozwoju

Stan trwałej oferty	Produkt Green Premium
Rozporządzenie REACH	Deklaracja REACH
Bez SVHC REACH	Tak
Europejska dyrektywa RoHS	Zgodność z pro-active (produkt poza zakresem obowiązywania dyrektywy UE RoHS) Europejska deklaracja RoHS
Bez toksycznych metali ciężkich	Tak
Bez rtęci	Tak
Norma RoHS Chiny	Dyrektywa RoHS Chiny
Informacje na temat zwolnienia z RoHS	Tak
Ujawnienie informacji o wpływie na środowisko	Środowiskowy Profil Produktu
Kulistość – profil	Informacja O Żywotności

Warunki gwarancji

Gwarancja	18 miesięcy
-----------	-------------

Karta danych technicznych ZB5AK1543

produktu

Dimensions Drawings

Dimensions

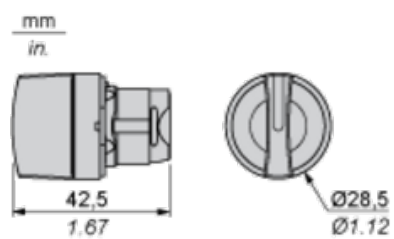

Karta danych technicznych ZB5AK1543

produktu

Mounting and Clearance

Panel Cut-out for Pushbuttons, Switches and Pilot Lights (Finished Holes, Ready for Installation)

Connection by Screw Clamp Terminals or Plug-in Connectors or on Printed Circuit Board

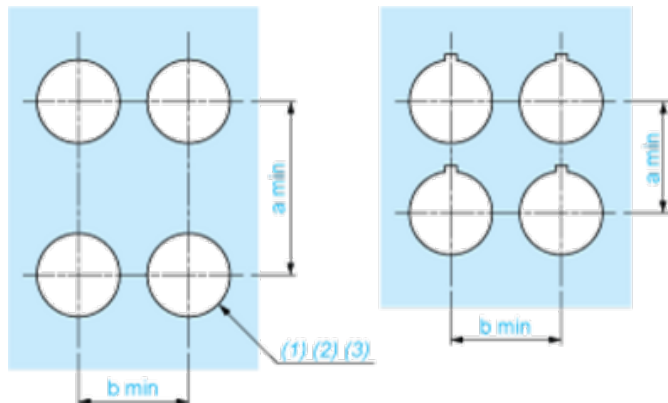

- (1) Diameter on finished panel or support
- (2) For selector switches and Emergency stop buttons, use of an anti-rotation plate type ZB5AZ902 is recommended.
- (3) $\varnothing 22.5$ mm recommended ($\varnothing 22.3_0^{+0.4}$) / $\varnothing 0.89$ in. recommended ($\varnothing 0.88$ in. $_0^{+0.016}$)

Connections	a in mm	a in in.	b in mm	b in in.
By screw clamp terminals or plug-in connector	40	1.57	30	1.18
By Faston connectors	45	1.77	32	1.26
On printed circuit board	30	1.18	30	1.18

Detail of Lug Recess



- (1) Diameter on finished panel or support
- (2) For selector switches and Emergency stop buttons, use of an anti-rotation plate type ZB5AZ902 is recommended.
- (3) $\varnothing 22.5$ mm recommended ($\varnothing 22.3_0^{+0.4}$) / $\varnothing 0.89$ in. recommended ($\varnothing 0.88$ in. $_0^{+0.016}$)

Pushbuttons, Switches and Pilot Lights for Printed Circuit Board Connection

Panel Cut-outs (Viewed from Installer's Side)

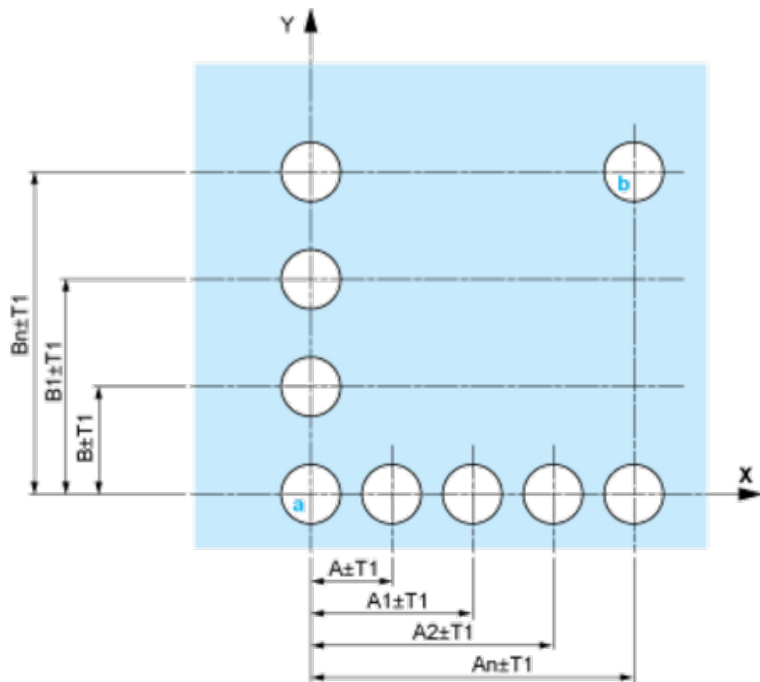

A: 30 mm min. / 1.18 in. min.

B: 40 mm min. / 1.57 in. min.

Printed Circuit Board Cut-outs (Viewed from Electrical Block Side)

Dimensions in mm

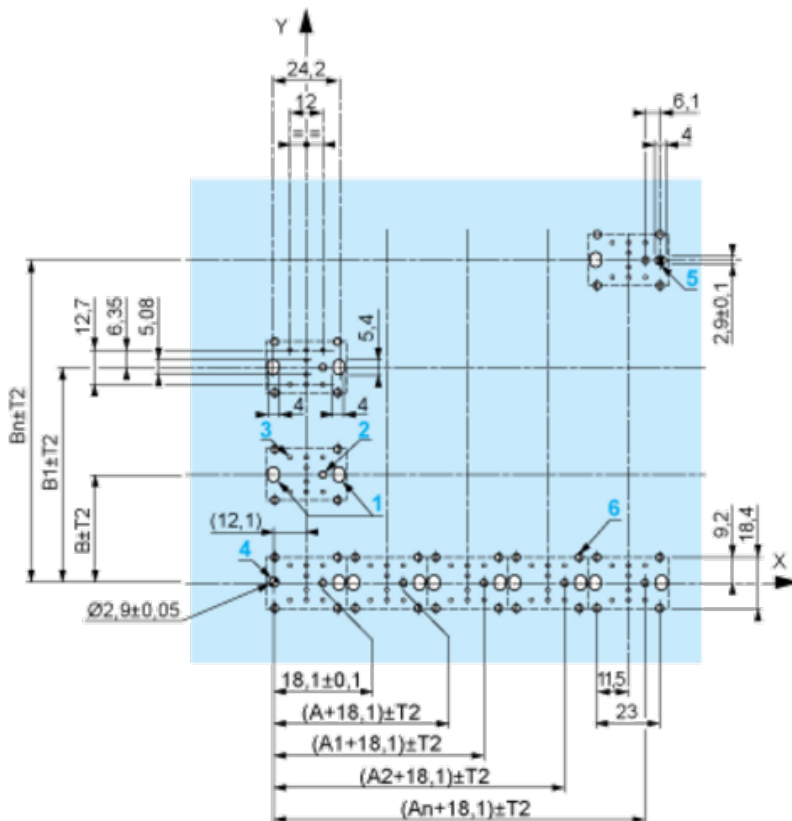

A: 30 mm min.

B: 40 mm min.

Dimensions in in.

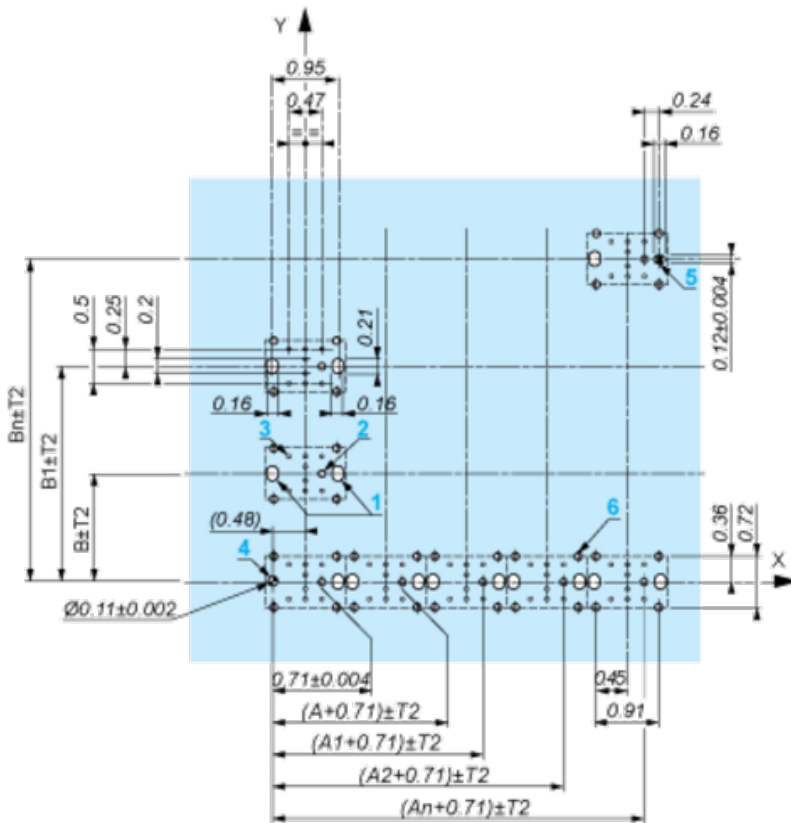

A: 1.18 in. min.

B: 1.57 in. min.

General Tolerances of the Panel and Printed Circuit Board

The cumulative tolerance must not exceed 0.3 mm / 0.012 in.: $T1 + T2 = 0.3 \text{ mm max.}$

Installation Precautions

- Minimum thickness of circuit board: 1.6 mm / 0.06 in.
- Cut-out diameter: 22.4 mm \pm 0.1 / 0.88 in. \pm 0.004
- Orientation of body/fixing collar ZB5AZ009: $\pm 2^\circ 30'$ (excluding cut-outs marked a and b).
- Tightening torque of screws ZBZ006: 0.6 N.m (5.3 lbf.in) max.
- Allow for one ZB5AZ079 fixing collar/pillar and its fixing screws:
 - every 90 mm / 3.54 in. horizontally (X), and 120 mm / 4.72 in. vertically (Y).
 - with each selector switch head (ZB5AD•, ZB5AJ•, ZB5AG•).

The fixing centers marked a and b are diagonally opposed and must align with those marked 4 and 5.



(1) Head ZB5AD•

(2) Panel

(2) Nut

(4) Printed circuit board

Mounting of Adapter (Socket) ZBZ01•

- 1 2 elongated holes for ZBZ006 screw access
- 2 1 hole \varnothing 2.4 mm \pm 0.05 / 0.09 in. \pm 0.002 for centring adapter ZBZ01•
- 3 8 \times \varnothing 1.2 mm / 0.05 in. holes
- 4 1 hole \varnothing 2.9 mm \pm 0.05 / 0.11 in. \pm 0.002, for aligning the printed circuit board (with cut-out marked a)
- 5 1 elongated hole for aligning the printed circuit board (with cut-out marked b)
- 6 4 holes \varnothing 2.4 mm / 0.09 in. for clipping in adapter ZBZ01•

Dimensions An + 18.1 relate to the \varnothing 2.4 mm \pm 0.05 / 0.09 in. \pm 0.002 holes for centring adapter ZBZ01•.

Karta danych technicznych ZB5AK1543

produktu

Technical Description

Electrical Composition Corresponding to Code M3

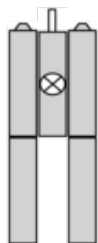

Electrical Composition Corresponding to Code M4

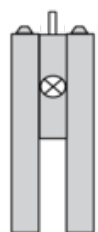

Electrical Composition Corresponding to Codes M6 and P2

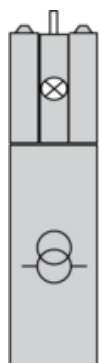

Electrical Composition Corresponding to Codes M5, M10, MF1, MR1 and MF2

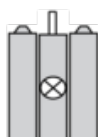

Legend

Single contact

Double contact

Light block





Possible location



Sequence of Contacts Fitted to 3-position Selector Switch Body

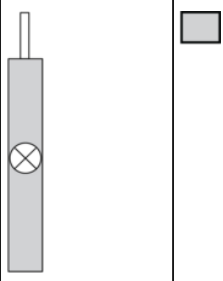



Position 315°



Push	Position	Top			
Bottom					
Location		Left	Right		
State		1	0		
Contacts	N/O		closed	open	
N/C		open	closed		





Position 0°



Push	Position	Top			
Bottom					
Location		Left	Right		
State		0	0		
Contacts	N/O		open	open	
N/C		closed	closed		

Position 45°



Push	Position	Top			
Bottom					
Location		Left	Right		
State		0	1		
Contacts	N/O		open	closed	
N/C		closed	open		