

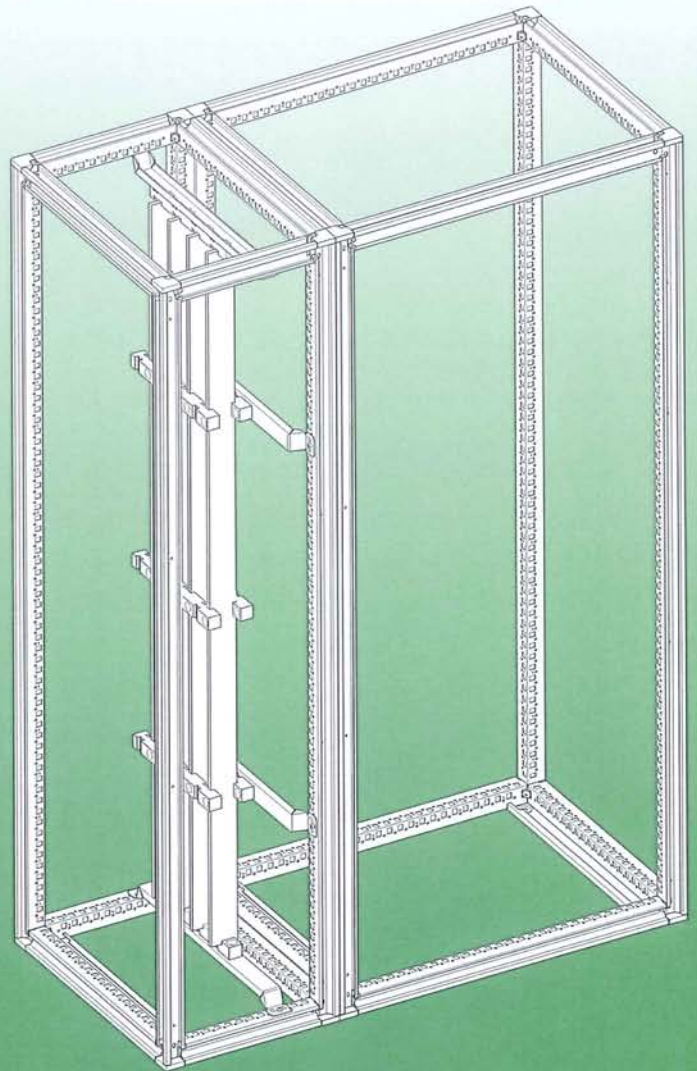





Vertical Bar Support
Up to 3.200A

Support Jeu de Barres
Vertical Jusqu'a 3.200A

Soporte de Barras Vertical
hasta 3.200A



	type 1 Ø M6 3 Nm 26,55 lb-in		type 2 Ø M6 3 Nm 26,55 lb-in		type 3 diam. 6		type 4 M6 3 Nm 26,55 lb-in		type 5 M6 3 Nm 26,55 lb-in		type 6 M6
---	--	---	--	---	--------------------------	---	--	---	--	---	---------------------

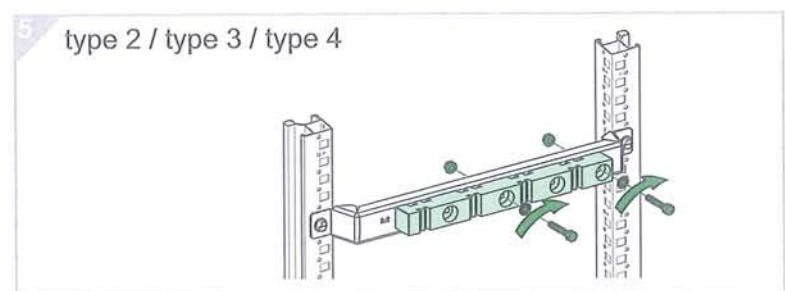
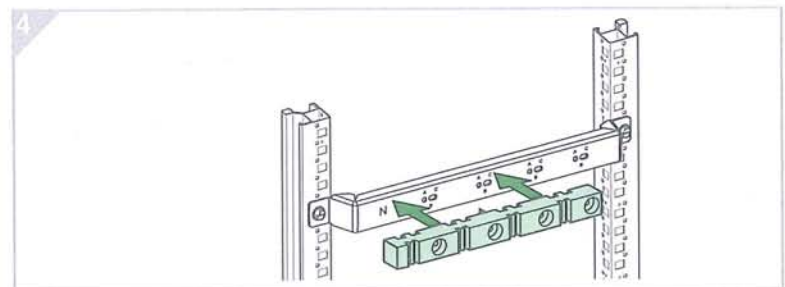
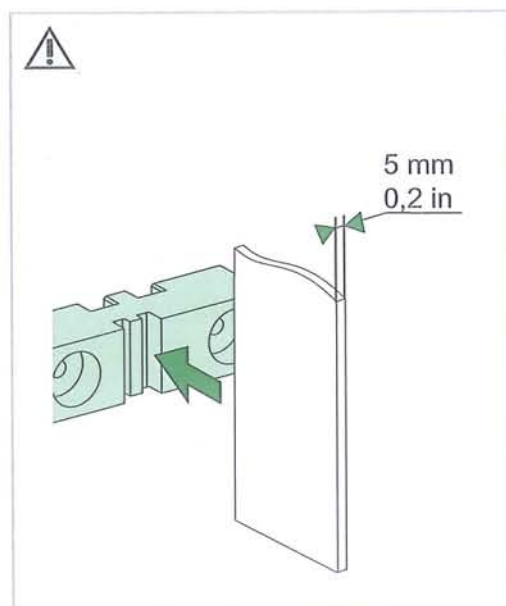
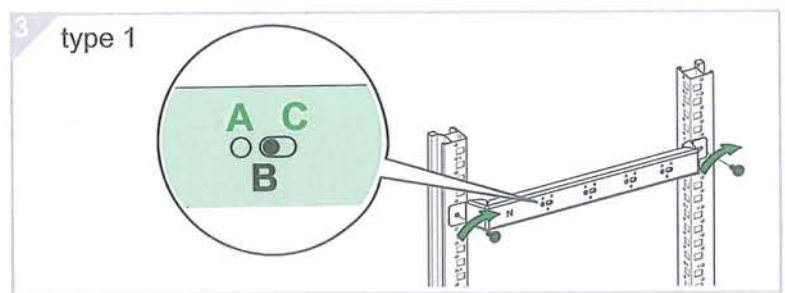
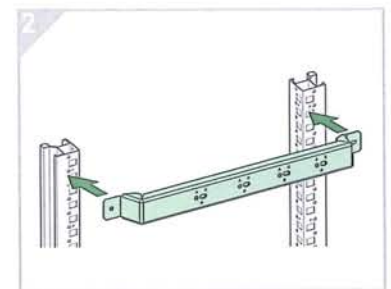
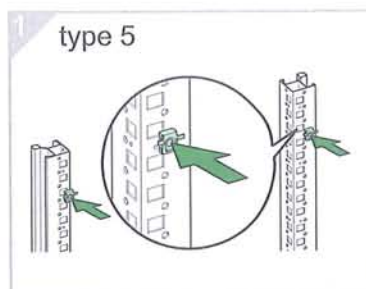
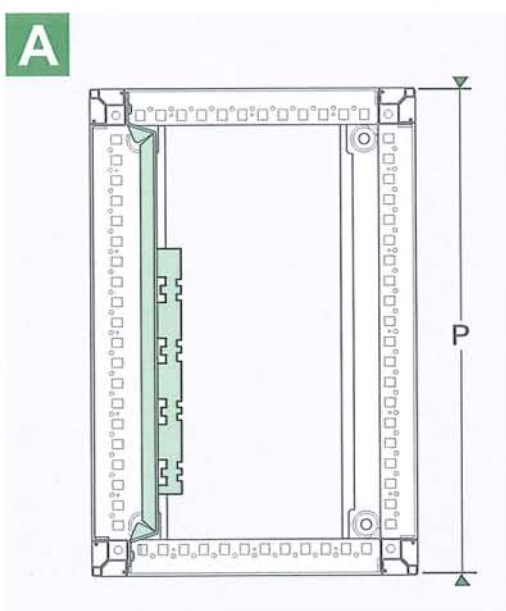
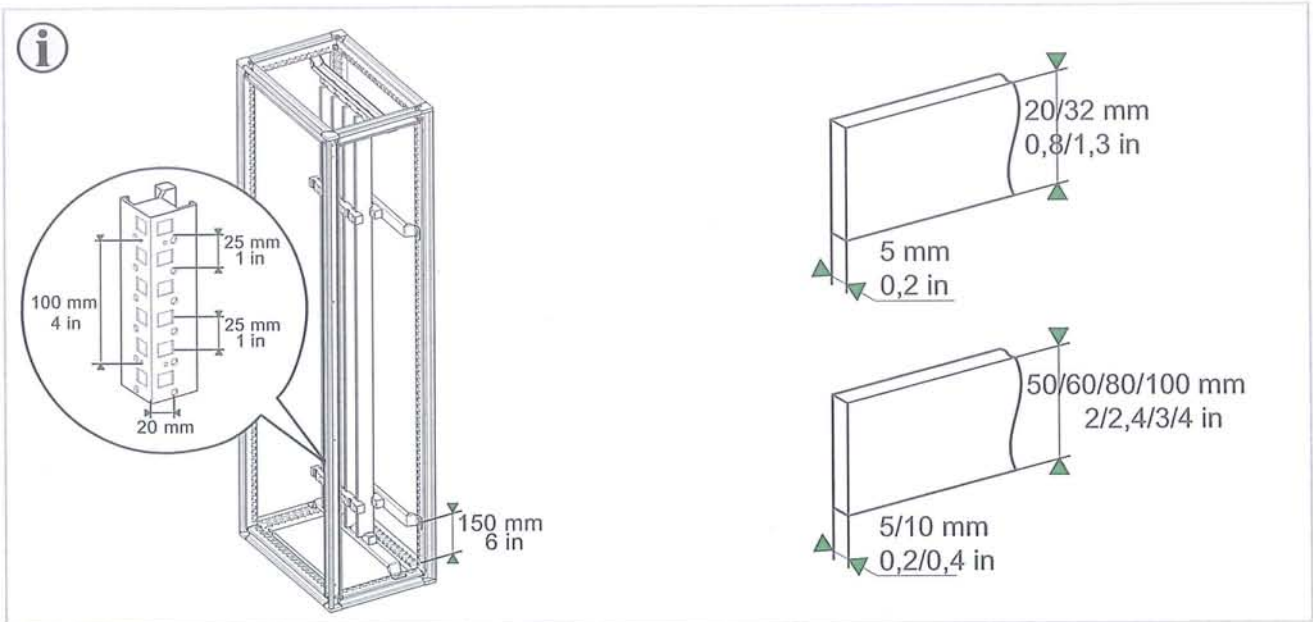

A'

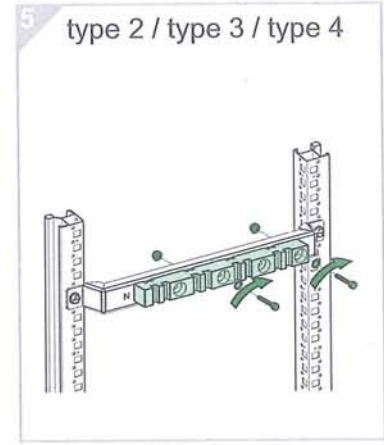
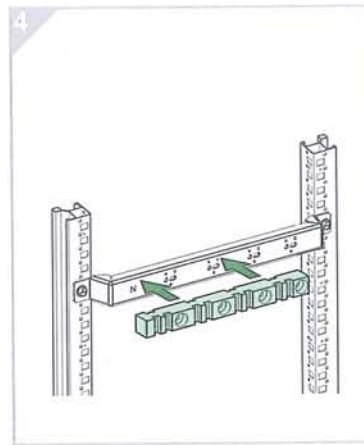
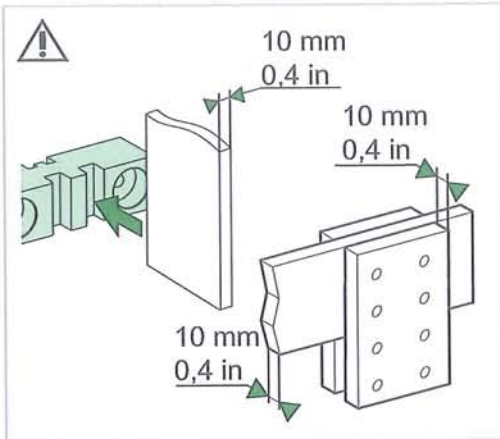
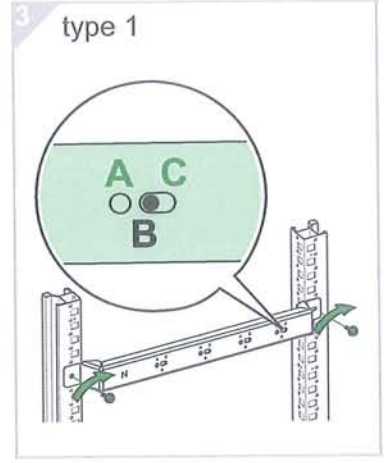
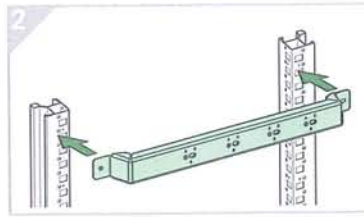
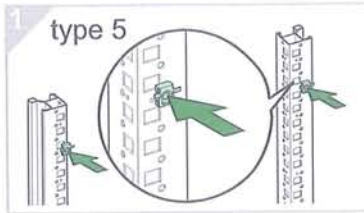
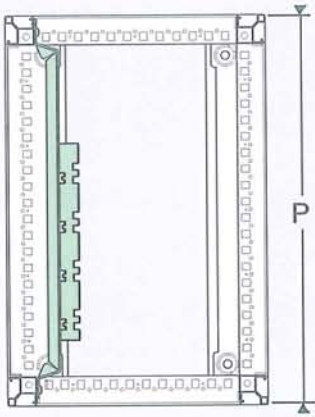

A''

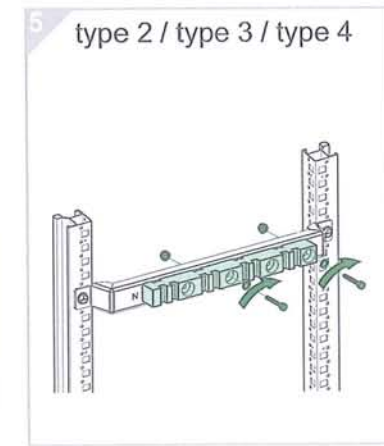
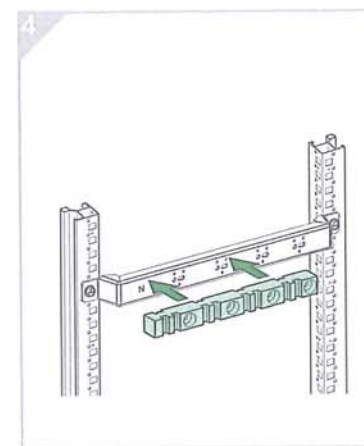
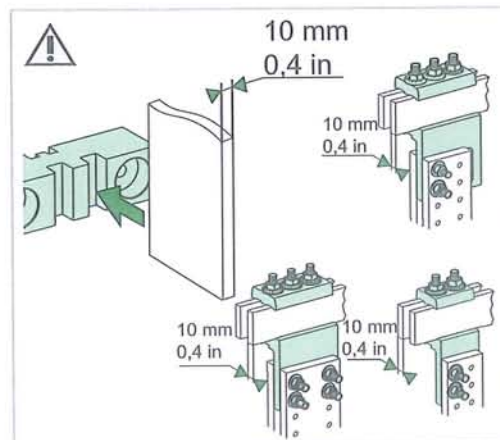
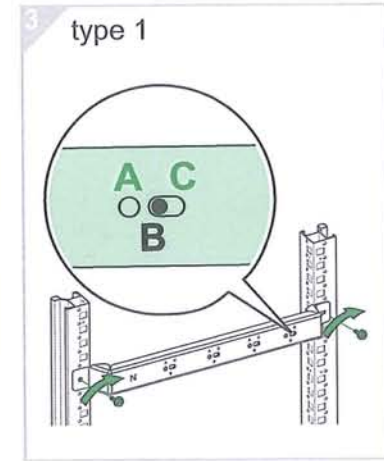
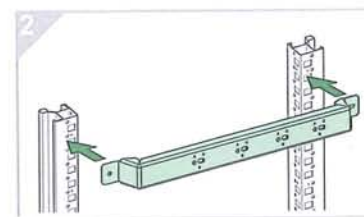
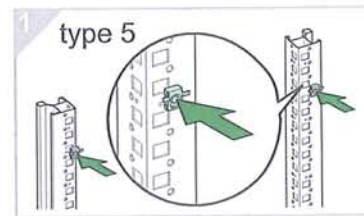
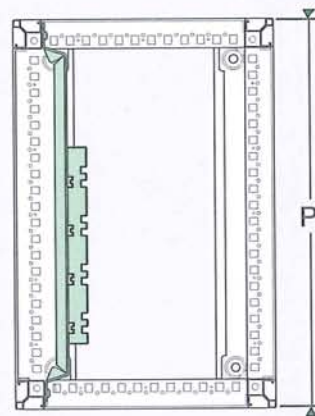

B

