

Niloe™
TV/SAT - TV/R/SAT sockets

Cat. Nos: 7 645 59/63 - 7 646 59/63 - 7 647 59/63

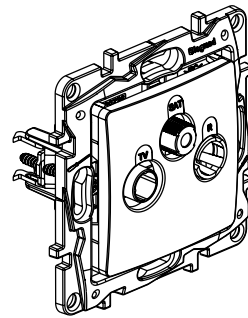
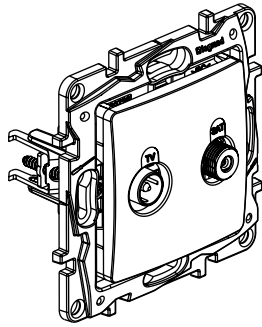

1. USE

TV/SAT: For receiving TV and satellite signals
 TV/R/SAT: For receiving TV, radio and satellite signals
 UHD (ultra high definition) compatible
 Class A shielding - Star wiring
 Low attenuation < 1.5 dB
 Recommended cable 17/19 VATC
 Single cable entry

2. RANGE

Item	Colour			No. of modules
	Ivoiry	White	Brown	
TV/R/SAT socket	7 646 63	7 645 63	7 647 63	2
TV/SAT socket	7 646 59	7 645 59	7 647 59	2

3. DIMENSIONS (mm)

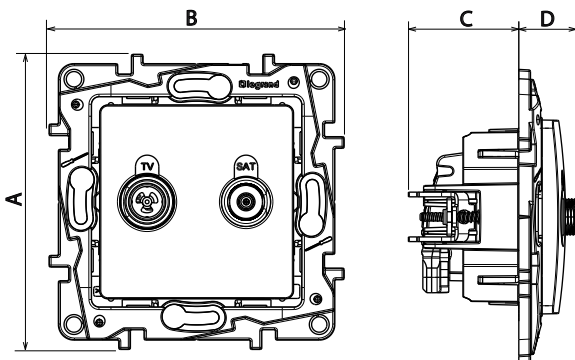

Item	A	B	C	D
7 645 63 - 7 646 63 - 7 647 63	75,8	75,8	28,3	14,8
7 645 59 - 7 646 59 - 7 647 59				

4. CONNECTION

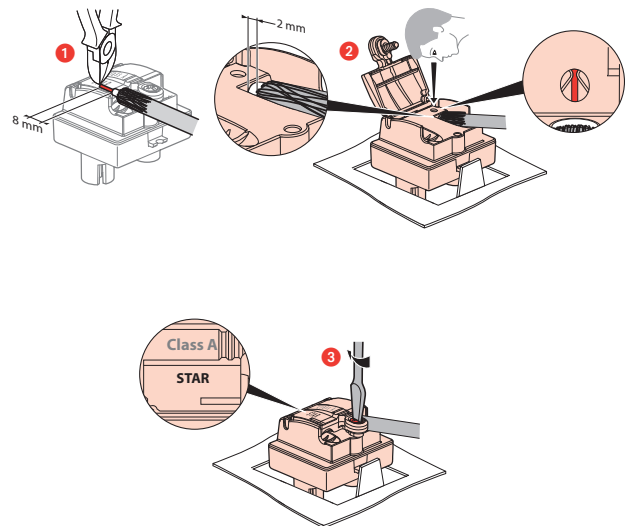

5. WIRING PRECAUTIONS

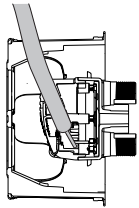
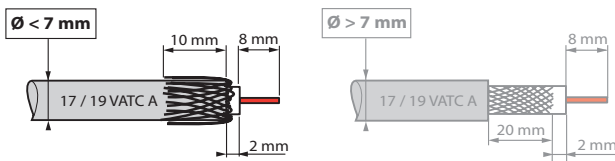

Connection from the rear of the socket reduces deformation of the coaxial cable, thus avoiding the risk of impedance loss and impaired performance.

6. TECHNICAL CHARACTERISTICS

6.1 Mechanical characteristics

Protection against solid bodies and liquids: IP 21
 Protection against impact: IK 04
 Cable strength 120 N: IEC 61169-24

6.2 Material characteristics

- Material:**
- Cover plate: ABS
 - Zero halogen
 - UV resistant
- Motor:**
- Casing: Zamac
 - Cover: Zamac
 - Pin: Bronze
 - Screws: Zinc-plated steel

6.3 Electrical characteristics

- Male connector \varnothing 9.52 mm (TV)
- Female connector (radio)
- Female F screw-type connector (SAT)
- Characteristic impedance: 75 ohm

Class A shielding efficiency (class A shielding is necessary to prevent interference from 3G and 4G phone signals, as these undesirable signals can cause pixellation of on-screen images or distort soundtracks)

- Frequency bands:
 - TV: 5-68/120-862 MHz
 - R: 87.5-108 MHz
 - SAT: 950-2400 MHz

- Insulation resistance: IEC 61169-24

6.4 Climate characteristics

Storage and operating temperature: -5 °C to +35 °C

7. CLEANING

Clean the surface with a cloth.
 Do not use acetone, tar-removing cleaning agents or trichloroethylene.
 Resistant to the following products: hexane (EN 60669-1), methylated spirit, soapy water, diluted ammonia, bleach diluted to 10%, window-cleaning products, pre-impregnated wipes.

Caution: Always test before using special cleaning products.

8. STANDARDS AND APPROVALS

- EN 50083-2
- Class A certificate

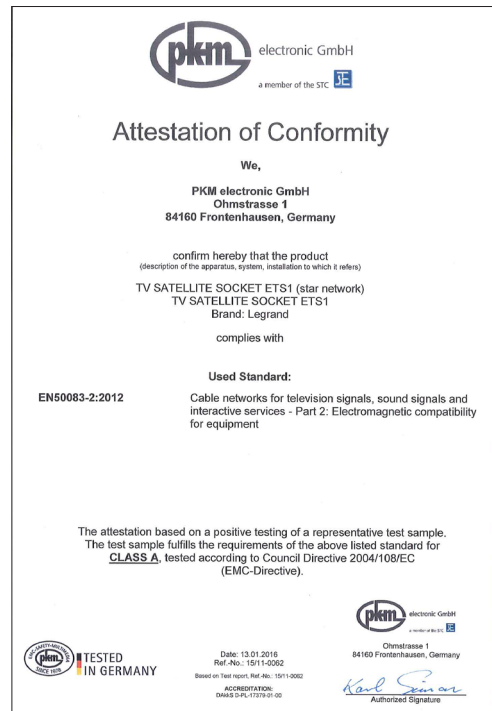
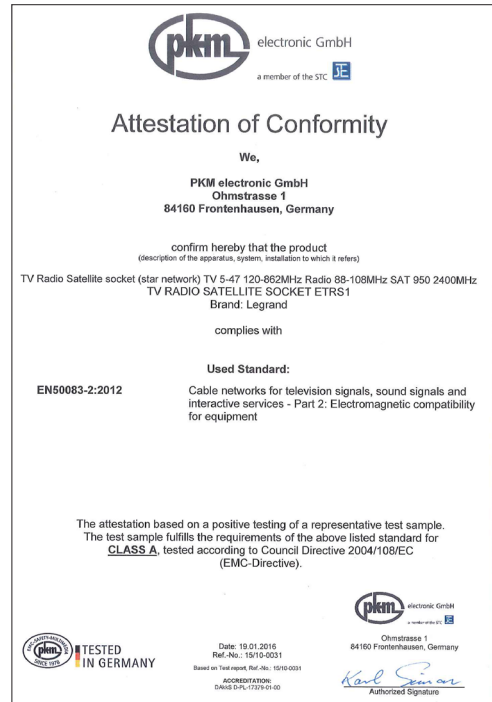

9. PERFORMANCE

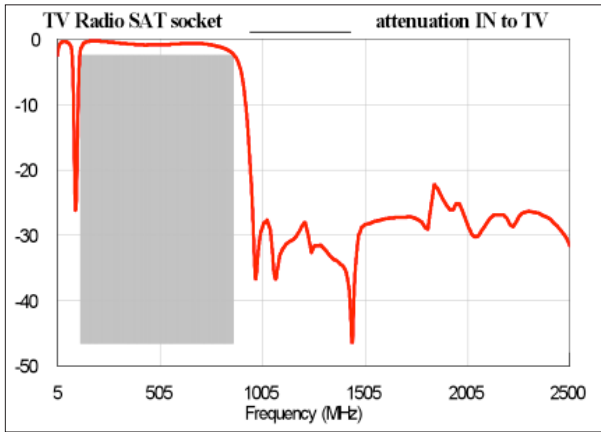

9. PERFORMANCE

